

brother

Embroidery Design Guide

Stickmuster-Katalog

Guide de motifs de broderie

Borduurontwerpen

bedieningshandleiding

Guida ai ricami

**Guía de diseños
de bordado**

**Guia de desenhos
de bordado**





● No.3

95 min	
1	(399)
2	(001)
3	(214)
4	(900)
5	(214)
↓ 193.4 mm	
↔ 238.5 mm	



No.6

7 min	
1	(328)
2	(330)
↓ 85.5 mm	
↔ 94.8 mm	



No.7

14 min	
1	(900)
↓ 84.8 mm	
↔ 131.1 mm	



● No.4

108 min	
1	(704)
2	(005)
3	(900)
4	(704)
5	(005)
6	(900)
7	(005)
8	(704)
9	(005)
10	(704)
11	(005)
12	(900)
13	(005)
↓ 195.0 mm	
↔ 264.5 mm	



No.8

31 min	
1	(085)
↓ 152.0 mm	
↔ 185.1 mm	



● No.5

15 min	
1	(613)
2	(086)
3	(070)
4	(613)
5	(070)
6	(534)
↓ 162.0 mm	
↔ 255.3 mm	



● No.9

113 min			
1	(307)	17	(507)
2	(900)	18	(085)
3	(307)	19	(807)
4	(807)	20	(085)
5	(513)	21	(807)
6	(507)	22	(085)
7	(513)	23	(307)
8	(507)	24	(807)
9	(513)	25	(513)
10	(507)	26	(507)
11	(807)	27	(807)
12	(513)	28	(507)
13	(507)	29	(513)
14	(513)	30	(085)
15	(507)	31	(807)
16	(513)	32	(085)
↓ 183.2 mm ↔ 277.5 mm			

Embroidery Patterns Color Change Table
 Tableau de changement de couleur des motifs de broderie
 Tabella dei cambi colore dei ricami
 Tabela de alteração de cor do padrão de bordado

Stickdesign-Farbtabelle
 Kleurenvogorde voor de borduurontwerpen
 Tabla de cambios de color para diseños de bordado



No.1 **7 min**

1 (800)
 2 (348)
 ↓ 50.0 mm
 ↔ 91.9 mm

No.2 **10 min**

1 (513)
 2 (085)
 3 (348)
 4 (620)
 ↓ 43.3 mm
 ↔ 148.2 mm

No.3 **15 min**

1 (534)
 2 (030)
 3 (208)
 ↓ 98.8 mm
 ↔ 109.7 mm



No.4 **30 min**

1 (542)
 2 (085)
 3 (812)
 4 (620)
 5 (030)
 ↓ 194.6 mm
 ↔ 276.9 mm



No.5 **6 min**

1 (542)
 2 (812)
 3 (030)
 ↓ 147.2 mm
 ↔ 44.2 mm

- ✂ Embroidery patterns
- ✂ Motifs de broderie
- ✂ Ricami
- ✂ Padrões de bordado

- ✂ Stickdesigns
- ✂ Borduurontwerpen
- ✂ Diseños de bordado



No.1 **4 min**

1 (107)
 2 (007)
 3 (005)
 4 (007)
 5 (107)
 ↓ 40.1 mm
 ↔ 41.3 mm

No.3 **1 min**

1 (612)
 2 (515)
 3 (534)
 4 (620)
 ↓ 28.2 mm
 ↔ 27.4 mm

No.5 **2 min**

1 (509)
 2 (515)
 ↓ 26.3 mm
 ↔ 26.6 mm

No.2 **2 min**

1 (812)
 2 (205)
 ↓ 32.1 mm
 ↔ 30.2 mm

No.4 **1 min**



1 (079)
 2 (001)
 3 (058)
 ↓ 19.1 mm
 ↔ 29.3 mm

No.6 **1 min**

1 (399)
 2 (348)
 ↓ 31.2 mm
 ↔ 21.1 mm

No.7

1 min

1  (328)
 2  (214)
 ↓ 37.6 mm
 ⇔ 15.3 mm



No.12







7 min

1  (005)
 ↓ 68.2 mm
 ⇔ 53.8 mm





No.17

39 min

1  (517)
 2  (214)
 3  (513)
 4  (070)
 5  (607)
 6  (214)
 7  (206)
 ↓ 192.5 mm
 ⇔ 192.5 mm

No.8

1 min

1  (001)
 2  (509)
 3  (058)
 ↓ 29.9 mm
 ⇔ 23.8 mm



No.13



2 min

1  (214)
 ↓ 39.3 mm
 ⇔ 38.4 mm



No.9

1 min

1  (900)
 2  (800)
 3  (900)
 ↓ 15.0 mm
 ⇔ 16.1 mm



No.14















6 min

1  (214)
 ↓ 68.5 mm
 ⇔ 69.5 mm











No.18

36 min

1  (399)
 2  (517)
 3  (607)
 4  (070)
 5  (804)
 6  (613)
 7  (214)
 8  (399)
 9  (517)
 10  (607)
 11  (070)
 12  (804)
 13  (613)
 14  (214)
 ↓ 185.9 mm
 ⇔ 185.9 mm

No.10





2 min

1  (348)
 2  (001)
 3  (517)
 4  (515)
 5  (323)
 6  (058)
 7  (214)
 8  (208)
 ↓ 30.8 mm
 ⇔ 27.6 mm



No.15







4 min

1  (348)
 2  (399)
 3  (085)
 4  (124)
 ↓ 41.4 mm
 ⇔ 49.3 mm







No.19

29 min

1  (513)
 2  (085)
 3  (807)
 4  (507)
 5  (209)
 6  (206)
 7  (807)
 ↓ 177.3 mm
 ⇔ 177.4 mm

No.11





2 min

1  (001)
 2  (515)
 3  (800)
 4  (214)
 5  (001)
 ↓ 31.0 mm
 ⇔ 30.9 mm



No.16

13 min

1  (348)
 2  (124)
 3  (085)
 4  (399)
 ↓ 88.1 mm
 ⇔ 157.9 mm



Embroidery Patterns Color Change Table
Tableau de changement de couleur des motifs de broderie
Tabella dei cambi colore dei ricami
Tabela de alteração de cor do padrão de bordado

Stickdesign-Farbtabelle
Kleurenvolgorde voor de borduurontwerpen
Tabla de cambios de color para diseños de bordado



No.20 **41 min**

1	(613)
2	(001)
3	(086)
4	(542)
5	(613)
6	(001)
7	(086)
8	(542)
9	(613)
10	(001)
11	(086)
12	(542)
13	(613)
14	(001)
15	(086)
16	(542)

↓ 194.0 mm
 ⇔ 194.0 mm

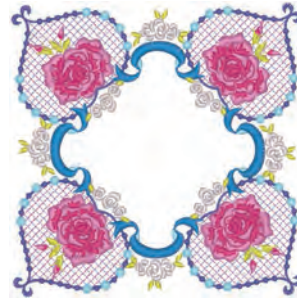

No.23 **37 min**

1	(804)
2	(810)
3	(607)
4	(017)
5	(019)
6	(085)
7	(086)
8	(027)
9	(124)

↓ 156.0 mm
 ⇔ 155.1 mm

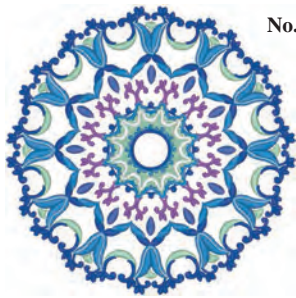

No.21 **36 min**

1	(612)	7	(542)
2	(405)	8	(405)
3	(542)	9	(019)
4	(001)	10	(001)
5	(019)	11	(070)
6	(405)		

↓ 153.0 mm ⇔ 153.5 mm



No.24 **23 min**

1	(107)
2	(086)

↓ 148.2 mm
 ⇔ 195.4 mm



No.22



No.25 **22 min**

1	(405)
2	(420)

↓ 148.2 mm
 ⇔ 195.4 mm



No.26 **22 min**

1	(517)
2	(515)

↓ 148.2 mm
 ⇔ 195.4 mm

51 min

1	(515)	15	(019)	29	(010)	43	(208)	57	(513)
2	(027)	16	(208)	30	(323)	44	(843)	58	(534)
3	(513)	17	(843)	31	(513)	45	(010)	59	(707)
4	(058)	18	(010)	32	(534)	46	(810)	60	(208)
5	(208)	19	(810)	33	(019)	47	(010)	61	(513)
6	(070)	20	(010)	34	(208)	48	(323)	62	(515)
7	(019)	21	(323)	35	(843)	49	(070)	63	(027)
8	(209)	22	(513)	36	(010)	50	(208)	64	(513)
9	(208)	23	(534)	37	(810)	51	(001)	65	(058)
10	(800)	24	(019)	38	(010)	52	(058)	66	(208)
11	(405)	25	(208)	39	(323)	53	(010)	67	(070)
12	(058)	26	(843)	40	(513)	54	(070)	68	(019)
13	(513)	27	(010)	41	(534)	55	(058)		
14	(534)	28	(810)	42	(019)	56	(620)		

↓ 195.8 mm ⇔ 195.8 mm



No.27 **22 min**

1	(007)
2	(405)

↓ 148.2 mm
 ⇔ 195.4 mm



No.28

56 min			
1	(208)	12	(307)
2	(323)	13	(126)
3	(126)	14	(333)
4	(058)	15	(208)
5	(800)	16	(126)
6	(107)	17	(001)
7	(058)	18	(800)
8	(001)	19	(058)
9	(126)	20	(107)
10	(399)	21	(399)
11	(107)	22	(058)
↓ 194.3 mm ↔ 145.2 mm			



No.31

10 min	
1	(399)
2	(001)
↓ 85.5 mm	
↔ 56.0 mm	



No.32

4 min	
1	(328)
↓ 74.1 mm	
↔ 54.1 mm	



No.29

42 min	
1	(208)
2	(900)
3	(620)
4	(339)
5	(900)
↓ 182.7 mm	
↔ 194.7 mm	



No.33

3 min	
1	(328)
2	(348)
↓ 42.4 mm	
↔ 40.1 mm	



No.30

51 min	
1	(420)
2	(515)
3	(206)
4	(420)
5	(007)
6	(800)
7	(515)
8	(206)
9	(007)
10	(005)
11	(420)
12	(800)
↓ 192.2 mm	
↔ 184.1 mm	



No.34

11 min			
1	(209)	6	(339)
2	(206)	7	(323)
3	(209)	8	(001)
4	(900)	9	(843)
5	(206)	10	(900)
↓ 55.2 mm ↔ 118.9 mm			

- ❖ Decoration/Hallmark patterns
- ❖ Motifs de décoration/d'emblème
- ❖ Ricami Decorazione/Stemma
- ❖ Desenhos decorativos/molduras e símbolos

- ❖ Dekor-/Ornamentmuster
- ❖ Ornamenten en decoratieve ontwerpen
- ❖ Diseños ornamentales/de marcos decorativos



No.1 **12 min**

1	█ (707)
2	█ (817)
3	█ (707)

↓ 195.6 mm
 ⇔ 160.0 mm

No.7 **1 min**

1	█ (900)
---	---------

↓ 18.9 mm
 ⇔ 62.7 mm

No.15 **2 min**

1	█ (900)
---	---------

↓ 8.1 mm
 ⇔ 182.8 mm

No.8 **6 min**

1	█ (900)
---	---------

↓ 62.4 mm
 ⇔ 123.6 mm



No.2 **4 min**

1	█ (817)
2	█ (707)

↓ 81.8 mm
 ⇔ 111.8 mm

No.9 **1 min**

1	█ (900)
---	---------

↓ 23.8 mm
 ⇔ 58.5 mm

No.16 **19 min**

1	█ (399)
2	█ (804)

↓ 186.8 mm
 ⇔ 160.1 mm

No.10 **1 min**

1	█ (900)
---	---------

↓ 40.6 mm
 ⇔ 74.9 mm



No.3 **3 min**

1	█ (707)
2	█ (817)

↓ 39.4 mm
 ⇔ 136.7 mm

No.11 **1 min**

1	█ (900)
---	---------

↓ 15.2 mm
 ⇔ 62.9 mm

No.17 **12 min**

1	█ (399)
2	█ (804)

↓ 84.6 mm
 ⇔ 143.0 mm

No.4 **2 min**

1	█ (900)
---	---------

↓ 25.0 mm
 ⇔ 69.8 mm

No.12 **3 min**

1	█ (900)
---	---------

↓ 37.8 mm
 ⇔ 125.4 mm

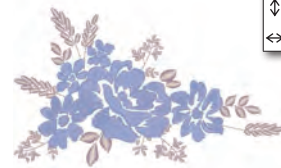

No.5 **2 min**

1	█ (900)
---	---------

↓ 40.5 mm
 ⇔ 90.3 mm

No.13 **3 min**

1	█ (900)
---	---------

↓ 24.7 mm
 ⇔ 129.1 mm

No.18 **10 min**

1	█ (399)
2	█ (804)

↓ 48.4 mm
 ⇔ 188.5 mm

No.6 **1 min**

1	█ (900)
---	---------

↓ 24.4 mm
 ⇔ 95.7 mm

No.14 **3 min**

1	█ (900)
---	---------

↓ 32.5 mm
 ⇔ 75.0 mm





No.19

19 min	
1	■ (328)
↓	173.7 mm
↔	194.4 mm



No.24

2 min	
1	■ (328)
↓	47.9 mm
↔	51.4 mm



No.25

1 min	
1	■ (869)
↓	26.0 mm
↔	57.0 mm



No.20

14 min	
1	■ (328)
↓	137.6 mm
↔	147.2 mm



No.26

2 min	
1	■ (007)
↓	16.8 mm
↔	92.6 mm



No.21

25 min	
1	■ (704)
↓	154.3 mm
↔	186.5 mm



No.27

1 min	
1	■ (005)
↓	20.7 mm
↔	33.7 mm



No.22

7 min	
1	■ (900)
2	■ (085)
3	■ (086)
4	■ (807)
↓	47.9 mm
↔	161.3 mm



No.23

4 min	
1	■ (005)
2	■ (817)
3	■ (607)
↓	77.3 mm
↔	95.1 mm

- ❖ Quilt patterns
- ❖ Motifs pour quilting (courtepointe)
- ❖ Ricami per quilting
- ❖ Desenhos de acolchoados

- ❖ Quilt-Stickmuster
- ❖ Quiltontwerpen
- ❖ Diseños de acolchado

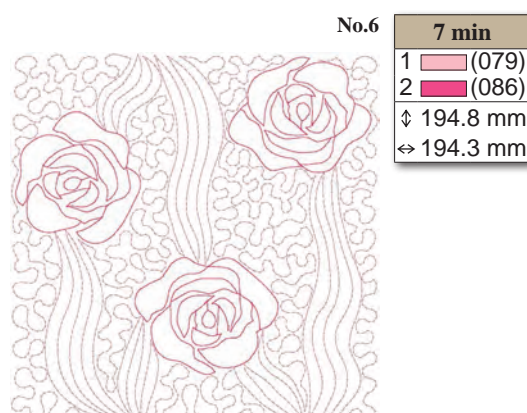
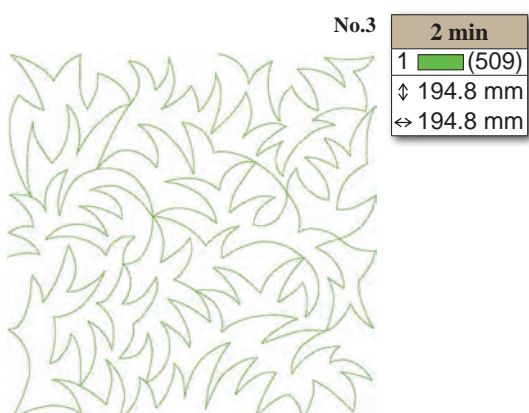
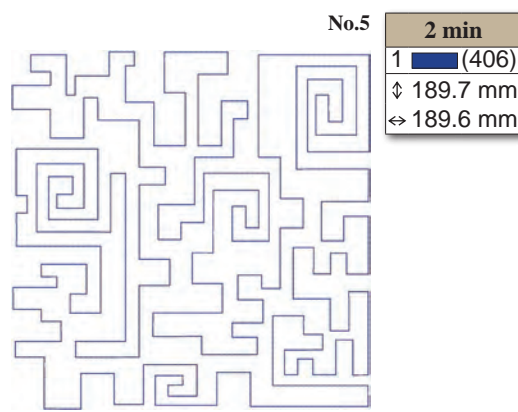
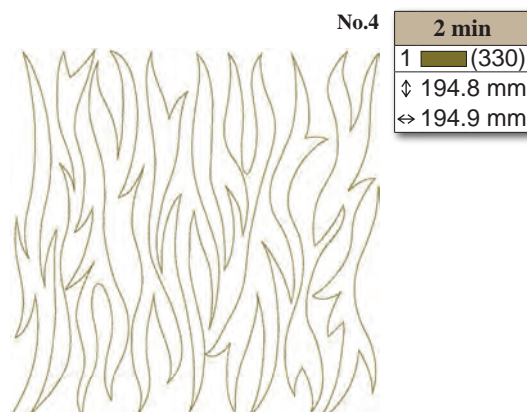
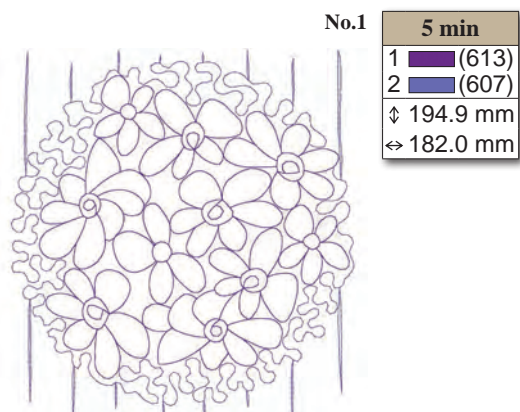

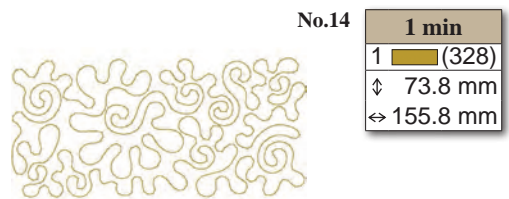
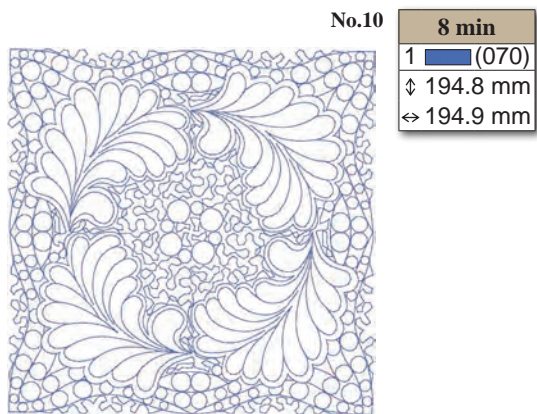
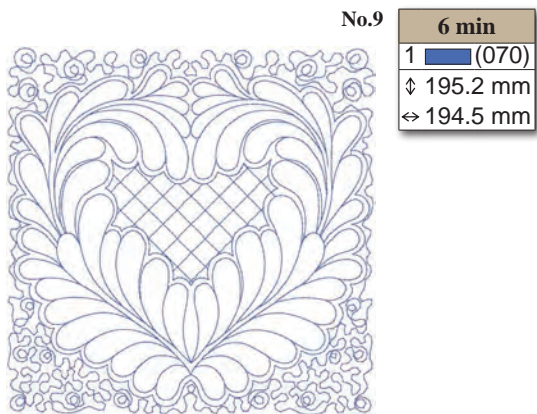
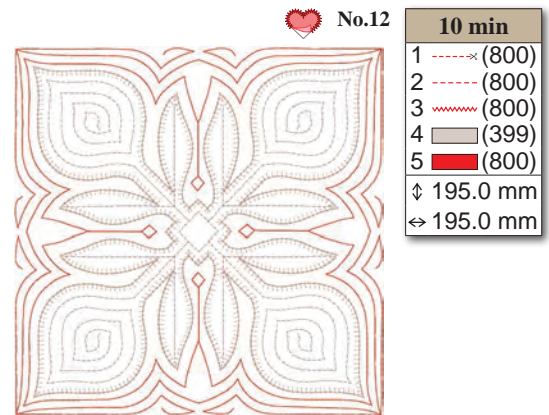
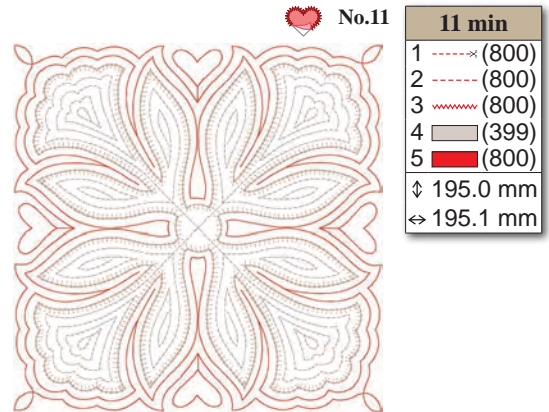
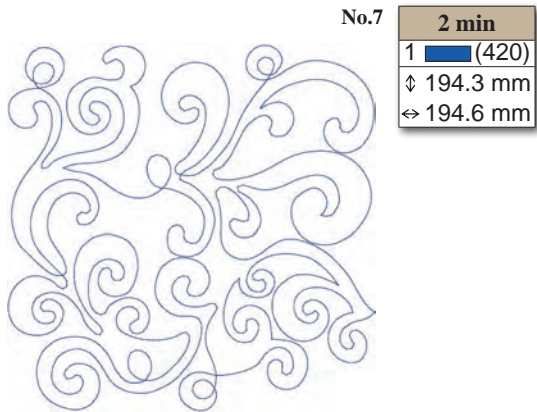

Embroidery Patterns Color Change Table
Tableau de changement de couleur des motifs de broderie
Tabella dei cambi colore dei ricami
Tabela de alteração de cor do padrão de bordado

Stickdesign-Farbtabelle
Kleurenvolgorde voor de borduurontwerpen
Tabla de cambios de color para diseños de bordado

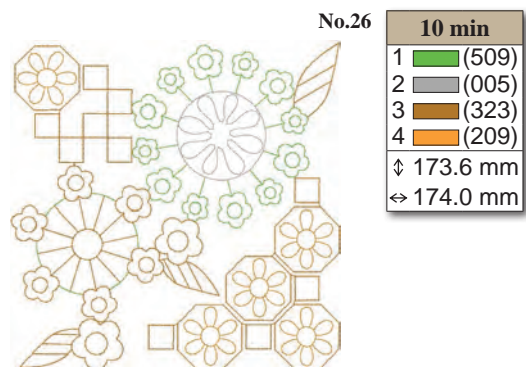
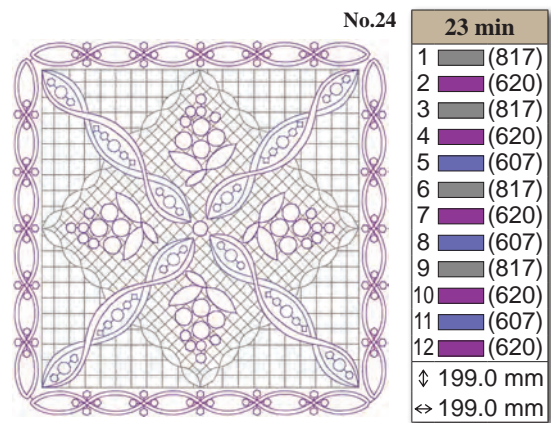
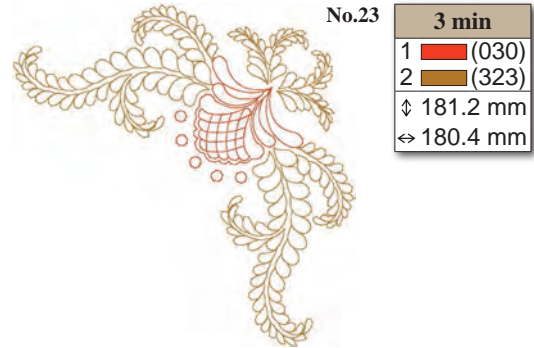
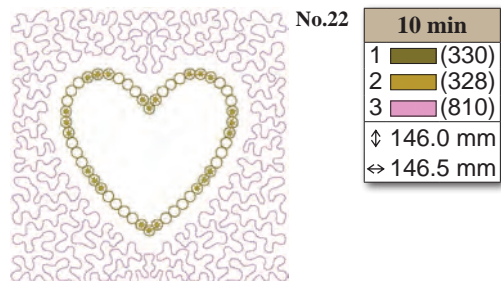
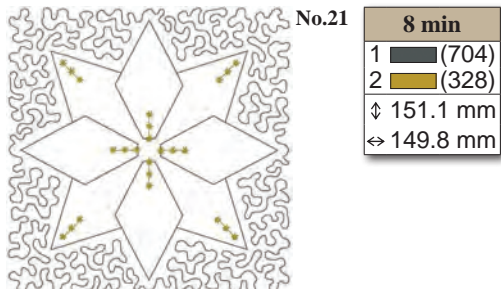
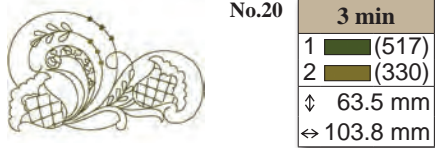
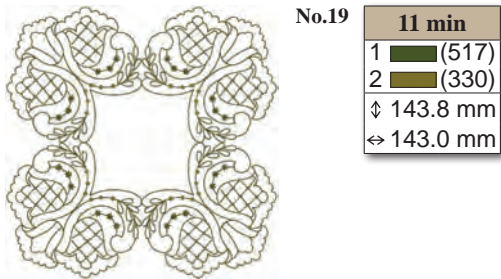
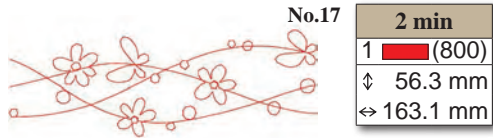

- ♥ Refer to the operation manual for the embroidery machine for details on how to embroider appliqués.
- ♥ Weitere Hinweise zum Stickten von Applikationen finden Sie in der Bedienungsanleitung der Stickmaschine.
- ♥ Reportez-vous au manuel d'instructions de la machine à broder pour plus d'informations sur la broderie des appliqués.
- ♥ Raadpleeg de bedieningshandleiding bij de borduurmachine voor gedetailleerde uitleg over het borduren van applicaties.
- ♥ Consultare il manuale di istruzioni della macchina per ricamare per i dettagli relativi al ricamo in appliqué.
- ♥ Consulte el manual de instrucciones de la máquina de bordar si desea más información sobre cómo bordar apliques.
- ♥ Consulte o manual de operações da máquina de bordar para obter detalhes sobre como bordar apliques.



No.27

2 min	
1	■ (323)
2	■ (509)
↓	180.9 mm
↔	45.3 mm



No.32

12 min	
1	■ (005)
2	■ (070)
3	■ (704)
4	■ (612)
↓	194.2 mm
↔	194.2 mm



No.28

3 min	
1	■ (517)
2	■ (208)
3	■ (800)
↓	123.9 mm
↔	59.4 mm



No.33

13 min	
1	■ (019)
2	■ (509)
3	■ (209)
4	■ (019)
5	■ (509)
↓	193.2 mm
↔	193.6 mm



No.29

3 min	
1	■ (214)
2	■ (330)
↓	95.3 mm
↔	83.5 mm

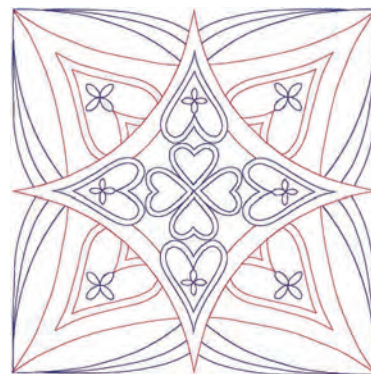

No.34

7 min	
1	■ (107)
2	■ (007)
3	■ (107)
↓	194.4 mm
↔	193.6 mm



No.30

2 min	
1	■ (330)
↓	44.2 mm
↔	162.8 mm



No.31

11 min	
1	■ (107)
2	■ (005)
3	■ (415)
4	■ (214)
↓	188.7 mm
↔	191.2 mm

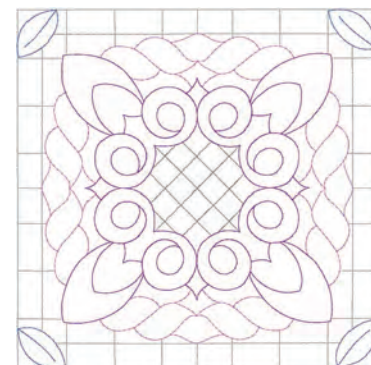

No.35

13 min	
1	■ (817)
2	■ (005)
3	■ (810)
4	■ (620)
5	■ (070)
↓	191.2 mm
↔	191.2 mm

Embroidery Patterns Color Change Table
 Tableau de changement de couleur des motifs de broderie
 Tabella dei cambi colore dei ricami
 Tabela de alteração de cor do padrão de bordado

Stickdesign-Farbtabelle
 Kleurenvolgeorde voor de borduurontwerpen
 Tabla de cambios de color para diseños de bordado

- ✂ Alphabet
- ✂ Alphabet
- ✂ Alfabeto
- ✂ Alfabeto
- ✂ Buchstaben
- ✂ Lettertypen
- ✂ Alfabeto



No.1 **9 min**



1	■ (030)
2	■ (900)
3	□ (001)
↓	68.3 mm
↔	60.2 mm

No.7 **9 min**



1	■ (019)
2	■ (900)
3	□ (001)
↓	62.5 mm
↔	54.3 mm

No.13 **11 min**



1	■ (612)
2	■ (900)
3	□ (001)
↓	63.5 mm
↔	68.4 mm

No.2 **9 min**



1	■ (030)
2	■ (900)
3	□ (001)
↓	64.7 mm
↔	57.1 mm

No.8 **8 min**



1	■ (019)
2	■ (900)
3	□ (001)
↓	64.6 mm
↔	55.9 mm

No.14 **11 min**



1	■ (612)
2	■ (900)
3	□ (001)
↓	68.7 mm
↔	63.2 mm

No.3 **10 min**



1	■ (030)
2	■ (900)
3	□ (001)
↓	61.3 mm
↔	55.0 mm

No.9 **7 min**



1	■ (019)
2	■ (900)
3	□ (001)
↓	75.7 mm
↔	41.8 mm

No.15 **7 min**



1	■ (612)
2	■ (900)
3	□ (001)
↓	69.1 mm
↔	44.5 mm

No.4 **8 min**



1	■ (030)
2	■ (900)
3	□ (001)
↓	64.3 mm
↔	60.3 mm

No.10 **7 min**



1	■ (019)
2	■ (900)
3	□ (001)
↓	66.2 mm
↔	48.3 mm

No.16 **8 min**



1	■ (612)
2	■ (900)
3	□ (001)
↓	64.0 mm
↔	57.6 mm

No.5 **9 min**



1	■ (030)
2	■ (900)
3	□ (001)
↓	68.4 mm
↔	55.1 mm

No.11 **12 min**



1	■ (019)
2	■ (900)
3	□ (001)
↓	72.8 mm
↔	72.5 mm

No.17 **9 min**



1	■ (509)
2	■ (900)
3	□ (001)
↓	63.7 mm
↔	53.8 mm

No.6 **7 min**



1	■ (019)
2	■ (900)
3	□ (001)
↓	67.8 mm
↔	47.9 mm

No.12 **7 min**



1	■ (612)
2	■ (900)
3	□ (001)
↓	71.0 mm
↔	47.8 mm

No.18 **10 min**



1	■ (509)
2	■ (900)
3	□ (001)
↓	64.6 mm
↔	58.1 mm

No.19 8 min



1	█ (509)
2	█ (900)
3	□ (001)
↓	64.6 mm
↔	50.2 mm

No.22 9 min



1	█ (509)
2	█ (900)
3	□ (001)
↓	71.1 mm
↔	60.7 mm

No.25 9 min



1	█ (817)
2	█ (900)
3	□ (001)
↓	67.9 mm
↔	50.7 mm

No.20 7 min



1	█ (509)
2	█ (900)
3	□ (001)
↓	62.9 mm
↔	52.5 mm

No.23 12 min



1	█ (817)
2	█ (900)
3	□ (001)
↓	66.9 mm
↔	74.9 mm

No.26 10 min



1	█ (817)
2	█ (900)
3	□ (001)
↓	67.8 mm
↔	63.8 mm

No.21 9 min



1	█ (509)
2	█ (900)
3	□ (001)
↓	64.8 mm
↔	50.1 mm

No.24 10 min



1	█ (817)
2	█ (900)
3	□ (001)
↓	74.9 mm
↔	67.9 mm



No.1 9 min



1	█ (399)
2	█ (019)
3	█ (900)
4	□ (001)
↓	71.5 mm
↔	55.1 mm

No.5 7 min



1	█ (405)
2	█ (900)
3	□ (001)
↓	73.8 mm
↔	54.8 mm

No.9 7 min



1	█ (019)
2	█ (900)
3	□ (001)
↓	74.6 mm
↔	43.9 mm

No.2 6 min



1	█ (208)
2	█ (900)
3	□ (001)
↓	72.5 mm
↔	40.8 mm

No.6 8 min



1	█ (612)
2	█ (900)
3	□ (001)
↓	70.8 mm
↔	52.3 mm

No.10 6 min



1	█ (800)
2	█ (900)
3	□ (001)
↓	72.7 mm
↔	47.6 mm

No.3 7 min



1	█ (509)
2	█ (900)
3	□ (001)
↓	70.6 mm
↔	52.4 mm

No.7 7 min



1	█ (126)
2	█ (900)
3	□ (001)
↓	72.2 mm
↔	56.4 mm

No.4 8 min



1	█ (005)
2	█ (900)
3	□ (001)
↓	67.7 mm
↔	51.4 mm

No.8 6 min



1	█ (205)
2	█ (900)
3	□ (001)
↓	69.5 mm
↔	58.4 mm

Embroidery Patterns Color Change Table
 Tableau de changement de couleur des motifs de broderie
 Tabella dei cambi colore dei ricami
 Tabela de alteração de cor do padrão de bordado

Stickdesign-Farbtabelle
 Kleurenvogorde voor de borduurontwerpen
 Tabla de cambios de color para diseños de bordado

- Vintage
- Retro
- Vintage

- Vintage
- Vintage

- Classique
- Antiquo





No.1 **17 min**
 1  (323)
 ↓ 148.0 mm
 ⇔ 129.6 mm





No.6 **16 min**
 1  (323)
 ↓ 149.3 mm
 ⇔ 107.4 mm





No.11 **21 min**
 1  (323)
 ↓ 149.4 mm
 ⇔ 125.1 mm





No.2 **18 min**
 1  (323)
 ↓ 149.9 mm
 ⇔ 110.9 mm





No.7 **18 min**
 1  (323)
 ↓ 150.4 mm
 ⇔ 111.7 mm





No.12 **13 min**
 1  (323)
 ↓ 149.2 mm
 ⇔ 107.1 mm





No.3 **14 min**
 1  (323)
 ↓ 152.9 mm
 ⇔ 102.3 mm





No.8 **21 min**
 1  (323)
 ↓ 149.1 mm
 ⇔ 125.6 mm





No.13 **28 min**
 1  (323)
 ↓ 149.2 mm
 ⇔ 150.1 mm





No.4 **18 min**
 1  (323)
 ↓ 149.3 mm
 ⇔ 111.7 mm





No.9 **10 min**
 1  (323)
 ↓ 149.1 mm
 ⇔ 58.0 mm





No.14 **21 min**
 1  (323)
 ↓ 149.7 mm
 ⇔ 131.1 mm





No.5 **19 min**
 1  (323)
 ↓ 149.1 mm
 ⇔ 109.7 mm



No.10 **11 min**
 1  (323)
 ↓ 148.8 mm
 ⇔ 93.9 mm



No.15 **19 min**
 1  (323)
 ↓ 151.7 mm
 ⇔ 107.1 mm



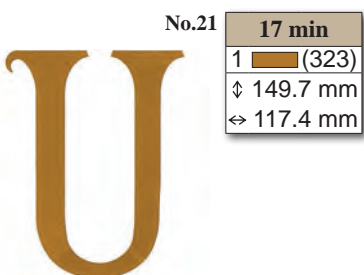
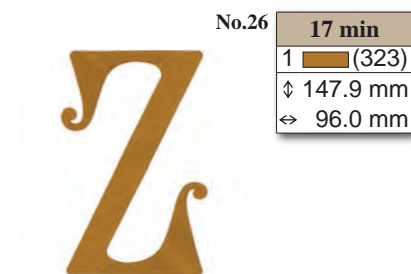
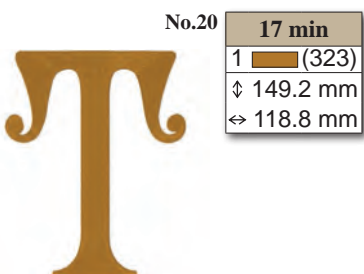
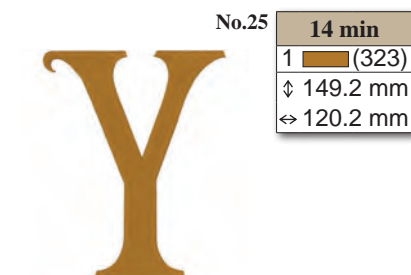
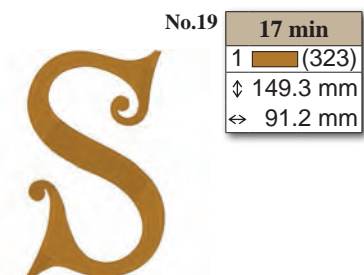
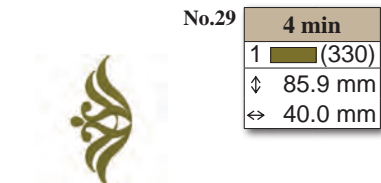
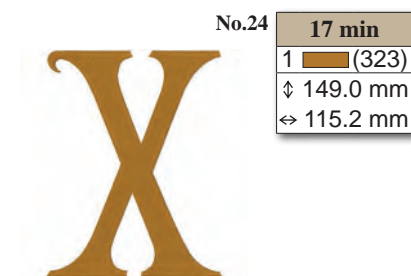
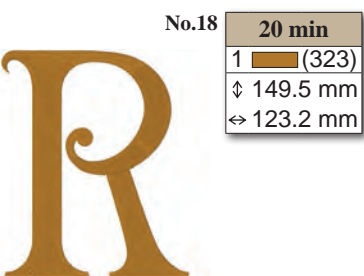
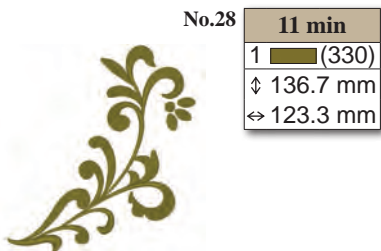
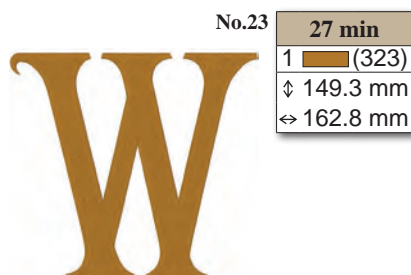
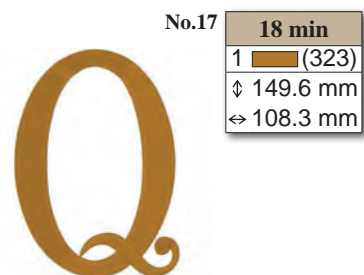
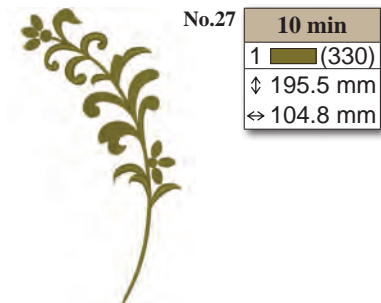
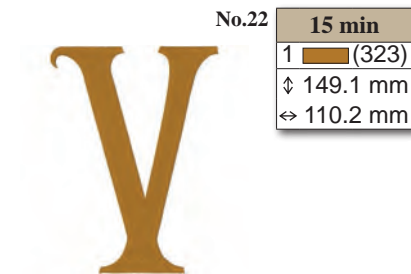
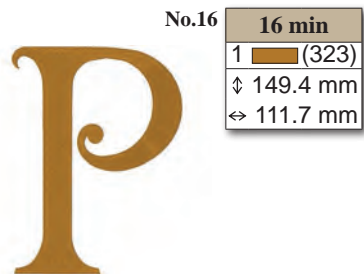

Embroidery Patterns Color Change Table
 Tableau de changement de couleur des motifs de broderie
 Tabella dei cambi colore dei ricami
 Tabela de alteração de cor do padrão de bordado

Stickdesign-Farbtabelle
 Kleurenvogorde voor de borduurontwerpen
 Tabla de cambios de color para diseños de bordado

- Floral
- Bloemen
- Floral
- Blumen
- Floreale
- Floral
- Floral



No.1 17 min

1	(328)
2	(804)
3	(612)
4	(079)
5	(807)
6	(513)
7	(502)

↓ 145.1 mm
 ⇐ 125.7 mm



No.6 16 min

1	(328)
2	(804)
3	(612)
4	(079)
5	(807)
6	(513)
7	(502)

↓ 142.8 mm
 ⇐ 101.8 mm



No.11 20 min

1	(328)
2	(804)
3	(612)
4	(079)
5	(807)
6	(513)
7	(502)

↓ 142.0 mm
 ⇐ 119.6 mm



No.2 20 min

1	(328)
2	(804)
3	(612)
4	(079)
5	(807)
6	(513)
7	(502)

↓ 140.9 mm
 ⇐ 108.1 mm



No.7 19 min

1	(328)
2	(804)
3	(612)
4	(079)
5	(807)
6	(513)
7	(502)

↓ 141.6 mm
 ⇐ 117.3 mm



No.12 15 min

1	(328)
2	(804)
3	(612)
4	(079)
5	(807)
6	(513)
7	(502)

↓ 144.9 mm
 ⇐ 107.0 mm



No.3 17 min

1	(328)
2	(804)
3	(612)
4	(079)
5	(807)
6	(513)
7	(502)

↓ 141.8 mm
 ⇐ 114.5 mm



No.8 22 min

1	(328)
2	(804)
3	(612)
4	(079)
5	(807)
6	(513)
7	(502)

↓ 141.7 mm
 ⇐ 121.6 mm



No.13 23 min

1	(328)
2	(804)
3	(612)
4	(079)
5	(807)
6	(513)
7	(502)

↓ 146.5 mm
 ⇐ 124.6 mm



No.4 19 min

1	(328)
2	(804)
3	(612)
4	(079)
5	(807)
6	(513)
7	(502)

↓ 141.2 mm
 ⇐ 108.3 mm



No.9 14 min

1	(328)
2	(804)
3	(612)
4	(079)
5	(807)
6	(513)
7	(502)

↓ 145.8 mm
 ⇐ 49.7 mm



No.14 20 min

1	(328)
2	(804)
3	(612)
4	(079)
5	(807)
6	(513)
7	(502)

↓ 147.0 mm
 ⇐ 116.8 mm



No.5 18 min

1	(328)
2	(804)
3	(612)
4	(079)
5	(807)
6	(513)
7	(502)

↓ 144.3 mm
 ⇐ 102.5 mm



No.10 15 min

1	(328)
2	(804)
3	(612)
4	(079)
5	(807)
6	(513)
7	(502)

↓ 144.5 mm
 ⇐ 82.3 mm



No.15 19 min

1	(328)
2	(804)
3	(612)
4	(079)
5	(807)
6	(513)
7	(502)

↓ 146.3 mm
 ⇐ 115.3 mm



No.16

17 min	
1	(328)
2	(804)
3	(612)
4	(079)
5	(807)
6	(513)
7	(502)
↓	143.4 mm
↔	99.6 mm



No.20

18 min	
1	(328)
2	(804)
3	(612)
4	(079)
5	(807)
6	(513)
7	(502)
↓	144.5 mm
↔	118.4 mm



No.24

19 min	
1	(328)
2	(804)
3	(612)
4	(079)
5	(807)
6	(513)
7	(502)
↓	142.3 mm
↔	115.9 mm



No.17

20 min	
1	(328)
2	(804)
3	(612)
4	(079)
5	(807)
6	(513)
7	(502)
↓	142.7 mm
↔	118.2 mm



No.21

18 min	
1	(328)
2	(804)
3	(612)
4	(079)
5	(807)
6	(513)
7	(502)
↓	144.6 mm
↔	118.5 mm



No.25

17 min	
1	(328)
2	(804)
3	(612)
4	(079)
5	(807)
6	(513)
7	(502)
↓	142.8 mm
↔	116.3 mm



No.18

21 min	
1	(328)
2	(804)
3	(612)
4	(079)
5	(807)
6	(513)
7	(502)
↓	143.4 mm
↔	112.5 mm



No.22

17 min	
1	(328)
2	(804)
3	(612)
4	(079)
5	(807)
6	(513)
7	(502)
↓	145.5 mm
↔	121.5 mm



No.26

19 min	
1	(328)
2	(804)
3	(612)
4	(079)
5	(807)
6	(513)
7	(502)
↓	142.8 mm
↔	92.9 mm



No.19

21 min	
1	(328)
2	(804)
3	(612)
4	(079)
5	(807)
6	(513)
7	(502)
↓	144.1 mm
↔	99.4 mm



No.23

23 min	
1	(328)
2	(804)
3	(612)
4	(079)
5	(807)
6	(513)
7	(502)
↓	146.2 mm
↔	124.8 mm

◆Example ◆Beispiel ◆Exemple ◆Voorbeeld
◆Esempio ◆Ejemplo ◆Example

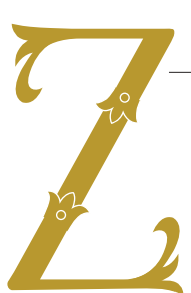

19 min	
1	(328)
2	(804)
3	(612)
4	(079)
5	(807)
6	(513)
7	(502)
↓	142.8 mm
↔	92.9 mm



No.27

3 min	
1	(328)
2	(079)
3	(807)
4	(513)
5	(502)
↓	51.9 mm
↔	45.9 mm



No.29

3 min	
1	(328)
2	(079)
3	(807)
4	(513)
5	(502)
↓	52.2 mm
↔	41.1 mm



No.31

3min	
1	(328)
2	(079)
3	(807)
4	(513)
5	(502)
↓	53.1 mm
↔	37.3 mm



No.28

3 min	
1	(328)
2	(079)
3	(807)
4	(513)
5	(502)
↓	51.7 mm
↔	39.6 mm



No.30

3 min	
1	(328)
2	(079)
3	(807)
4	(513)
5	(502)
↓	51.9 mm
↔	39.3 mm



No.32

3 min	
1	(328)
2	(079)
3	(807)
4	(513)
5	(502)
↓	52.1 mm
↔	36.6 mm



Embroidery Patterns Color Change Table
Tableau de changement de couleur des motifs de broderie
Tabella dei cambi colore dei ricami
Tabela de alteração de cor do padrão de bordado

Stickdesign-Farbtabelle
Kleurenvolgorde voor de borduurontwerpen
Tabla de cambios de color para diseños de bordado

No.33 **3 min**



1	(328)
2	(079)
3	(807)
4	(513)
5	(502)

↓ 51.9 mm
↔ 42.7 mm

No.38 **3 min**



1	(328)
2	(079)
3	(807)
4	(513)
5	(502)

↓ 52.5 mm
↔ 38.9 mm

No.43 **3 min**



1	(328)
2	(079)
3	(807)
4	(513)
5	(502)

↓ 52.6 mm
↔ 43.3 mm

No.48 **3 min**



1	(328)
2	(079)
3	(807)
4	(513)
5	(502)

↓ 52.8 mm
↔ 43.9 mm

No.34 **4 min**



1	(328)
2	(079)
3	(807)
4	(513)
5	(502)

↓ 52.2 mm
↔ 44.3 mm

No.39 **5 min**



1	(328)
2	(079)
3	(807)
4	(513)
5	(502)

↓ 53.3 mm
↔ 46.4 mm

No.44 **4 min**



1	(328)
2	(079)
3	(807)
4	(513)
5	(502)

↓ 52.3 mm
↔ 40.7 mm

No.49 **4 min**



1	(328)
2	(079)
3	(807)
4	(513)
5	(502)

↓ 53.3 mm
↔ 46.5 mm

No.35 **3 min**



1	(328)
2	(079)
3	(807)
4	(513)
5	(502)

↓ 53.9 mm
↔ 23.8 mm

No.40 **4 min**



1	(328)
2	(079)
3	(807)
4	(513)
5	(502)

↓ 52.9 mm
↔ 43.1 mm

No.45 **3 min**



1	(328)
2	(079)
3	(807)
4	(513)
5	(502)

↓ 52.6 mm
↔ 35.0 mm

No.50 **3 min**



1	(328)
2	(079)
3	(807)
4	(513)
5	(502)

↓ 51.7 mm
↔ 42.0 mm

No.36 **3 min**



1	(328)
2	(079)
3	(807)
4	(513)
5	(502)

↓ 52.6 mm
↔ 30.1 mm

No.41 **3 min**



1	(328)
2	(079)
3	(807)
4	(513)
5	(502)

↓ 52.8 mm
↔ 42.6 mm

No.46 **3 min**



1	(328)
2	(079)
3	(807)
4	(513)
5	(502)

↓ 53.0 mm
↔ 42.0 mm

No.51 **3 min**



1	(328)
2	(079)
3	(807)
4	(513)
5	(502)

↓ 53.8 mm
↔ 42.2 mm

No.37 **4 min**



1	(328)
2	(079)
3	(807)
4	(513)
5	(502)

↓ 52.4 mm
↔ 43.4 mm

No.42 **3 min**



1	(328)
2	(079)
3	(807)
4	(513)
5	(502)

↓ 52.1 mm
↔ 36.9 mm

No.47 **3 min**



1	(328)
2	(079)
3	(807)
4	(513)
5	(502)

↓ 52.5 mm
↔ 42.8 mm

No.52 **3 min**



1	(328)
2	(079)
3	(807)
4	(513)
5	(502)

↓ 52.4 mm
↔ 33.4 mm

No.53 **2 min**



1	(804)
2	(612)
3	(079)
4	(807)
5	(513)
6	(502)

↓ 34.4 mm
↔ 22.7 mm

No.55



3 min					
1	(804)	3	(079)	5	(513)
2	(612)	4	(807)	6	(502)

↓ 39.3 mm ↔ 75.4 mm

No.57



6 min											
1	(804)	7	(804)	13	(079)						
2	(612)	8	(612)	14	(807)						
3	(079)	9	(079)	15	(513)						
4	(807)	10	(807)	16	(502)						
5	(513)	11	(513)								
6	(502)	12	(502)								

↓ 27.9 mm ↔ 121.9 mm

No.54 **2 min**



1	(079)
2	(807)
3	(513)
4	(502)

↓ 39.8 mm
↔ 25.6 mm

No.56



6 min											
1	(804)	5	(513)	9	(079)						
2	(612)	6	(502)	10	(807)						
3	(079)	7	(804)	11	(513)						
4	(807)	8	(612)	12	(502)						

↓ 23.4 mm ↔ 123.7 mm



No. 58

11 min		
1 (079)	7 (513)	13 (079)
2 (807)	8 (502)	14 (807)
3 (513)	9 (079)	15 (513)
4 (502)	10 (807)	16 (502)
5 (079)	11 (513)	
6 (807)	12 (502)	
↓ 103.6 mm ↔ 94.9 mm		



No.60

4 min	
1 (513)	2 (807)
3 (513)	4 (807)
↓ 106.7 mm ↔ 93.4 mm	



No.63

1 min	
1 (513)	
↓ 147.2 mm ↔ 61.8 mm	



No.61

3 min	
1 (513)	2 (807)
3 (513)	4 (807)
↓ 42.6 mm ↔ 142.0 mm	



No.64



No.59

20 min		
1 (079)	17 (513)	33 (804)
2 (807)	18 (502)	34 (612)
3 (804)	19 (079)	35 (513)
4 (612)	20 (807)	36 (502)
5 (513)	21 (804)	37 (079)
6 (502)	22 (612)	38 (807)
7 (079)	23 (513)	39 (804)
8 (807)	24 (502)	40 (612)
9 (804)	25 (079)	41 (513)
10 (612)	26 (807)	42 (502)
11 (513)	27 (804)	43 (079)
12 (502)	28 (612)	44 (807)
13 (079)	29 (513)	45 (804)
14 (807)	30 (502)	46 (612)
15 (804)	31 (079)	47 (513)
16 (612)	32 (807)	48 (502)
↓ 195.4 mm ↔ 157.3 mm		



No.62

11 min		
1 (513)	4 (807)	7 (513)
2 (807)	5 (513)	8 (807)
3 (513)	6 (807)	
↓ 195.4 mm ↔ 158.5 mm		

7 min	
1 (804)	13 (804)
2 (612)	14 (612)
3 (079)	15 (079)
4 (807)	16 (807)
5 (513)	17 (513)
6 (502)	18 (502)
7 (804)	19 (804)
8 (612)	20 (612)
9 (079)	21 (079)
10 (807)	22 (807)
11 (513)	23 (513)
12 (502)	24 (502)
↓ 73.3 mm ↔ 72.8 mm	

Embroidery Patterns Color Change Table
Tableau de changement de couleur des motifs de broderie
Tabella dei cambi colore dei ricami
Tabela de alteração de cor do padrão de bordado

Stickdesign-Farbtabelle
Kleurenvolgorde voor de borduurontwerpen
Tabla de cambios de color para diseños de bordado

- Line
- Sierlijk
- Lineare

- Linie
- Fune

- Ligne
- Línea



No.1

L: 13 min	
S: 9 min	
1	■ (005)
2	■ (807)
↓ 125.1 mm	
L:	↔ 103.3 mm
↓ 95.9 mm	
S:	↔ 79.1 mm



No.4

L: 14 min	
S: 10 min	
1	■ (005)
2	■ (807)
↓ 124.8 mm	
L:	↔ 95.8 mm
↓ 95.8 mm	
S:	↔ 73.8 mm



No.7

L: 12 min	
S: 8 min	
1	■ (005)
2	■ (807)
↓ 125.0 mm	
L:	↔ 87.6 mm
↓ 95.8 mm	
S:	↔ 67.2 mm



No.2

L: 13 min	
S: 9 min	
1	■ (005)
2	■ (807)
↓ 124.8 mm	
L:	↔ 86.6 mm
↓ 95.7 mm	
S:	↔ 66.4 mm



No.5

L: 14 min	
S: 10 min	
1	■ (005)
2	■ (807)
↓ 124.8 mm	
L:	↔ 87.8 mm
↓ 95.8 mm	
S:	↔ 67.4 mm



No.8

L: 15 min	
S: 10 min	
1	■ (005)
2	■ (807)
↓ 125.0 mm	
L:	↔ 89.8 mm
↓ 95.7 mm	
S:	↔ 68.8 mm



No.3

L: 11 min	
S: 8 min	
1	■ (005)
2	■ (807)
↓ 124.8 mm	
L:	↔ 85.6 mm
↓ 95.8 mm	
S:	↔ 65.8 mm



No.6

L: 13 min	
S: 9 min	
1	■ (005)
2	■ (807)
↓ 124.8 mm	
L:	↔ 80.6 mm
↓ 95.8 mm	
S:	↔ 61.8 mm



No.9

L: 7 min	
S: 5 min	
1	■ (005)
2	■ (807)
↓ 124.9 mm	
L:	↔ 66.0 mm
↓ 95.8 mm	
S:	↔ 50.6 mm



No.10

L: 9 min	
S: 6 min	
1	█ (005)
2	█ (807)
↓	124.9 mm
L: ↔	75.4 mm
↓	95.8 mm
S: ↔	57.8 mm



No.13

L: 18 min	
S: 13 min	
1	█ (005)
2	█ (807)
↓	125.0 mm
L: ↔	117.6 mm
↓	95.8 mm
S: ↔	90.4 mm



No.16

L: 13 min	
S: 9 min	
1	█ (005)
2	█ (807)
↓	125.0 mm
L: ↔	82.6 mm
↓	95.8 mm
S: ↔	63.2 mm



No.11

L: 13 min	
S: 9 min	
1	█ (005)
2	█ (807)
↓	125.0 mm
L: ↔	95.6 mm
↓	95.8 mm
S: ↔	73.4 mm



No.14

L: 15 min	
S: 10 min	
1	█ (005)
2	█ (807)
↓	124.8 mm
L: ↔	96.0 mm
↓	95.8 mm
S: ↔	73.6 mm



No.17

L: 15 min	
S: 10 min	
1	█ (005)
2	█ (807)
↓	124.8 mm
L: ↔	160.4 mm
↓	96.0 mm
S: ↔	123.2 mm



No.12

L: 12 min	
S: 9 min	
1	█ (005)
2	█ (807)
↓	124.9 mm
L: ↔	88.1 mm
↓	95.8 mm
S: ↔	67.6 mm



No.15

L: 13 min	
S: 9 min	
1	█ (005)
2	█ (807)
↓	124.6 mm
L: ↔	96.8 mm
↓	95.8 mm
S: ↔	74.4 mm



No.18

L: 11 min	
S: 7 min	
1	█ (005)
2	█ (807)
↓	124.8 mm
L: ↔	79.6 mm
↓	95.8 mm
S: ↔	61.2 mm



Embroidery Patterns Color Change Table
Tableau de changement de couleur des motifs de broderie
Tabella dei cambi colore dei ricami
Tabela de alteração de cor do padrão de bordado

Stickdesign-Farbtabelle
Kleurenvolgorde voor de borduurontwerpen
Tabla de cambios de color para diseños de bordado

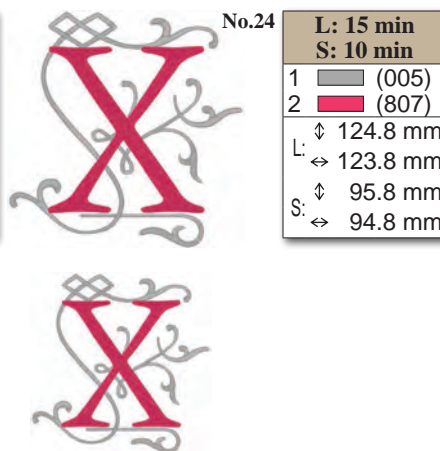
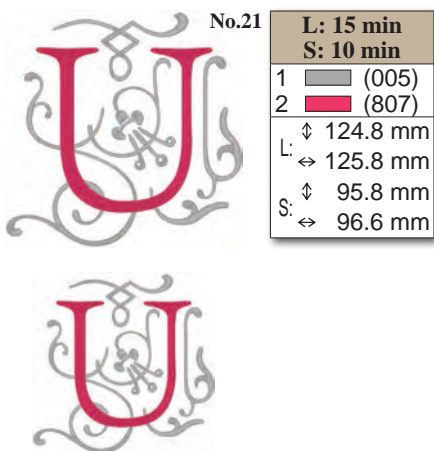
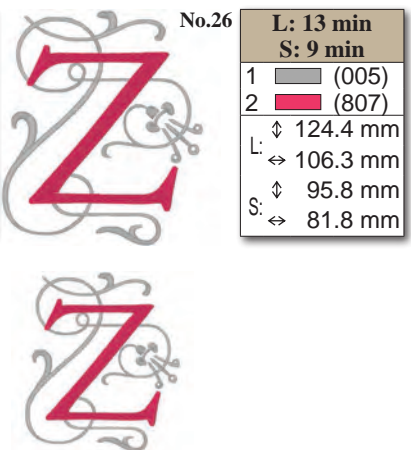
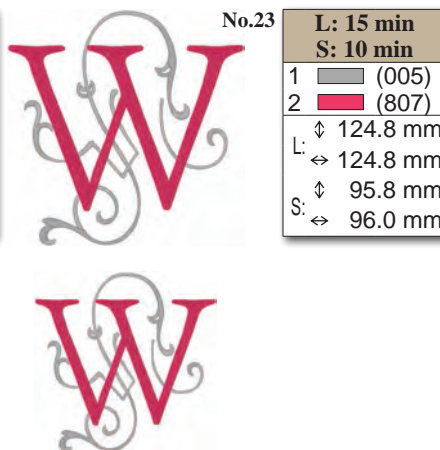
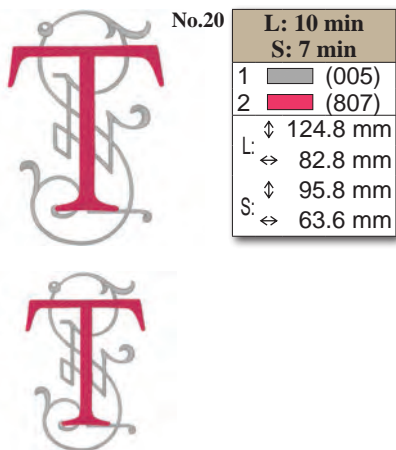
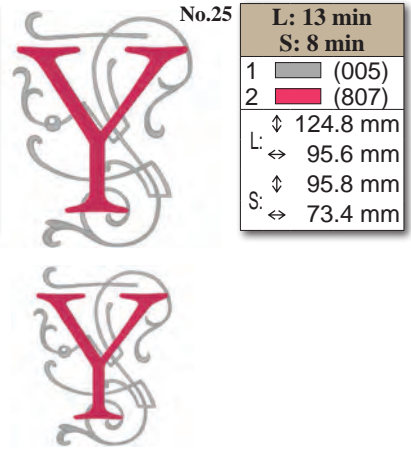
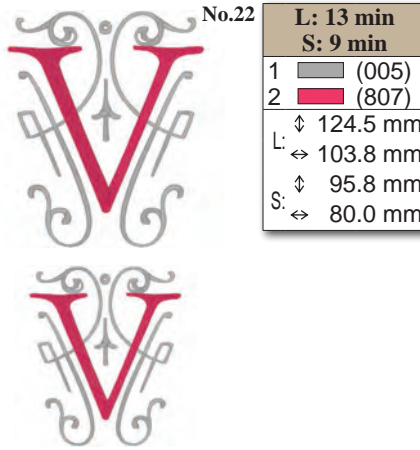
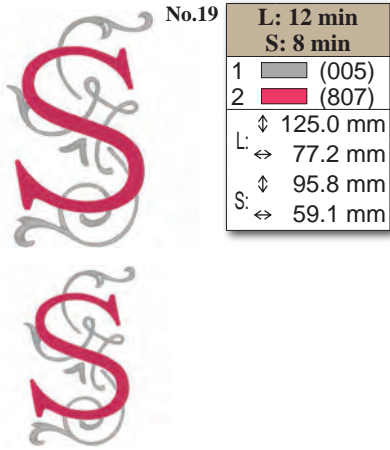































Patterns No.1 - No.26, are designed by Hang to Dry.
 Designs Nr.1 - Nr.26 wurden von Hang to Dry entworfen.
 Les motifs n° 1 à 26 sont conçus par Hang to Dry.
 De ontwerpen 1-26 zijn ontworpen door Hang to Dry.
 I ricami dal N° 1 al N° 26 sono stati ideati da Hang to Dry.
 Los diseños del N°1 al N° 26 están diseñados por Hang to Dry.
 Desenhos N° 1 a N° 26 criados por Hang to Dry.

- Vine
- Wijnrank
- Videira

- Reben
- Vite

- Vigne
- Vid



<p>No.1</p>  <table border="1" style="margin-left: 10px;"> <tr><td colspan="2" style="text-align: center;">4 min</td></tr> <tr><td>1</td><td> (620)</td></tr> <tr><td>2</td><td> (612)</td></tr> <tr><td>↓</td><td>54.3 mm</td></tr> <tr><td>↔</td><td>82.8 mm</td></tr> </table>	4 min		1	(620)	2	(612)	↓	54.3 mm	↔	82.8 mm	<p>No.9</p>  <table border="1" style="margin-left: 10px;"> <tr><td colspan="2" style="text-align: center;">3 min</td></tr> <tr><td>1</td><td> (620)</td></tr> <tr><td>2</td><td> (612)</td></tr> <tr><td>↓</td><td>55.0 mm</td></tr> <tr><td>↔</td><td>68.3 mm</td></tr> </table>	3 min		1	(620)	2	(612)	↓	55.0 mm	↔	68.3 mm	<p>No.17</p>  <table border="1" style="margin-left: 10px;"> <tr><td colspan="2" style="text-align: center;">3 min</td></tr> <tr><td>1</td><td> (620)</td></tr> <tr><td>2</td><td> (612)</td></tr> <tr><td>↓</td><td>54.9 mm</td></tr> <tr><td>↔</td><td>83.5 mm</td></tr> </table>	3 min		1	(620)	2	(612)	↓	54.9 mm	↔	83.5 mm	<p>No.25</p>  <table border="1" style="margin-left: 10px;"> <tr><td colspan="2" style="text-align: center;">3 min</td></tr> <tr><td>1</td><td> (620)</td></tr> <tr><td>2</td><td> (612)</td></tr> <tr><td>↓</td><td>53.1 mm</td></tr> <tr><td>↔</td><td>65.9 mm</td></tr> </table>	3 min		1	(620)	2	(612)	↓	53.1 mm	↔	65.9 mm
4 min																																											
1	(620)																																										
2	(612)																																										
↓	54.3 mm																																										
↔	82.8 mm																																										
3 min																																											
1	(620)																																										
2	(612)																																										
↓	55.0 mm																																										
↔	68.3 mm																																										
3 min																																											
1	(620)																																										
2	(612)																																										
↓	54.9 mm																																										
↔	83.5 mm																																										
3 min																																											
1	(620)																																										
2	(612)																																										
↓	53.1 mm																																										
↔	65.9 mm																																										
<p>No.2</p>  <table border="1" style="margin-left: 10px;"> <tr><td colspan="2" style="text-align: center;">3 min</td></tr> <tr><td>1</td><td> (620)</td></tr> <tr><td>2</td><td> (612)</td></tr> <tr><td>↓</td><td>54.4 mm</td></tr> <tr><td>↔</td><td>72.6 mm</td></tr> </table>	3 min		1	(620)	2	(612)	↓	54.4 mm	↔	72.6 mm	<p>No.10</p>  <table border="1" style="margin-left: 10px;"> <tr><td colspan="2" style="text-align: center;">3 min</td></tr> <tr><td>1</td><td> (620)</td></tr> <tr><td>2</td><td> (612)</td></tr> <tr><td>↓</td><td>54.3 mm</td></tr> <tr><td>↔</td><td>71.0 mm</td></tr> </table>	3 min		1	(620)	2	(612)	↓	54.3 mm	↔	71.0 mm	<p>No.18</p>  <table border="1" style="margin-left: 10px;"> <tr><td colspan="2" style="text-align: center;">4 min</td></tr> <tr><td>1</td><td> (620)</td></tr> <tr><td>2</td><td> (612)</td></tr> <tr><td>↓</td><td>54.7 mm</td></tr> <tr><td>↔</td><td>81.5 mm</td></tr> </table>	4 min		1	(620)	2	(612)	↓	54.7 mm	↔	81.5 mm	<p>No.26</p>  <table border="1" style="margin-left: 10px;"> <tr><td colspan="2" style="text-align: center;">3 min</td></tr> <tr><td>1</td><td> (620)</td></tr> <tr><td>2</td><td> (612)</td></tr> <tr><td>↓</td><td>55.9 mm</td></tr> <tr><td>↔</td><td>70.0 mm</td></tr> </table>	3 min		1	(620)	2	(612)	↓	55.9 mm	↔	70.0 mm
3 min																																											
1	(620)																																										
2	(612)																																										
↓	54.4 mm																																										
↔	72.6 mm																																										
3 min																																											
1	(620)																																										
2	(612)																																										
↓	54.3 mm																																										
↔	71.0 mm																																										
4 min																																											
1	(620)																																										
2	(612)																																										
↓	54.7 mm																																										
↔	81.5 mm																																										
3 min																																											
1	(620)																																										
2	(612)																																										
↓	55.9 mm																																										
↔	70.0 mm																																										
<p>No.3</p>  <table border="1" style="margin-left: 10px;"> <tr><td colspan="2" style="text-align: center;">3 min</td></tr> <tr><td>1</td><td> (620)</td></tr> <tr><td>2</td><td> (612)</td></tr> <tr><td>↓</td><td>53.9 mm</td></tr> <tr><td>↔</td><td>73.3 mm</td></tr> </table>	3 min		1	(620)	2	(612)	↓	53.9 mm	↔	73.3 mm	<p>No.11</p>  <table border="1" style="margin-left: 10px;"> <tr><td colspan="2" style="text-align: center;">3 min</td></tr> <tr><td>1</td><td> (620)</td></tr> <tr><td>2</td><td> (612)</td></tr> <tr><td>↓</td><td>55.2 mm</td></tr> <tr><td>↔</td><td>85.3 mm</td></tr> </table>	3 min		1	(620)	2	(612)	↓	55.2 mm	↔	85.3 mm	<p>No.19</p>  <table border="1" style="margin-left: 10px;"> <tr><td colspan="2" style="text-align: center;">3 min</td></tr> <tr><td>1</td><td> (620)</td></tr> <tr><td>2</td><td> (612)</td></tr> <tr><td>↓</td><td>54.5 mm</td></tr> <tr><td>↔</td><td>73.8 mm</td></tr> </table>	3 min		1	(620)	2	(612)	↓	54.5 mm	↔	73.8 mm	<p>No.27</p>  <table border="1" style="margin-left: 10px;"> <tr><td colspan="2" style="text-align: center;">3 min</td></tr> <tr><td>1</td><td> (620)</td></tr> <tr><td>2</td><td> (612)</td></tr> <tr><td>↓</td><td>57.4 mm</td></tr> <tr><td>↔</td><td>57.7 mm</td></tr> </table>	3 min		1	(620)	2	(612)	↓	57.4 mm	↔	57.7 mm
3 min																																											
1	(620)																																										
2	(612)																																										
↓	53.9 mm																																										
↔	73.3 mm																																										
3 min																																											
1	(620)																																										
2	(612)																																										
↓	55.2 mm																																										
↔	85.3 mm																																										
3 min																																											
1	(620)																																										
2	(612)																																										
↓	54.5 mm																																										
↔	73.8 mm																																										
3 min																																											
1	(620)																																										
2	(612)																																										
↓	57.4 mm																																										
↔	57.7 mm																																										
<p>No.4</p>  <table border="1" style="margin-left: 10px;"> <tr><td colspan="2" style="text-align: center;">4 min</td></tr> <tr><td>1</td><td> (620)</td></tr> <tr><td>2</td><td> (612)</td></tr> <tr><td>↓</td><td>54.6 mm</td></tr> <tr><td>↔</td><td>80.0 mm</td></tr> </table>	4 min		1	(620)	2	(612)	↓	54.6 mm	↔	80.0 mm	<p>No.12</p>  <table border="1" style="margin-left: 10px;"> <tr><td colspan="2" style="text-align: center;">3 min</td></tr> <tr><td>1</td><td> (620)</td></tr> <tr><td>2</td><td> (612)</td></tr> <tr><td>↓</td><td>53.9 mm</td></tr> <tr><td>↔</td><td>75.0 mm</td></tr> </table>	3 min		1	(620)	2	(612)	↓	53.9 mm	↔	75.0 mm	<p>No.20</p>  <table border="1" style="margin-left: 10px;"> <tr><td colspan="2" style="text-align: center;">3 min</td></tr> <tr><td>1</td><td> (620)</td></tr> <tr><td>2</td><td> (612)</td></tr> <tr><td>↓</td><td>54.2 mm</td></tr> <tr><td>↔</td><td>73.2 mm</td></tr> </table>	3 min		1	(620)	2	(612)	↓	54.2 mm	↔	73.2 mm	<p>No.28</p>  <table border="1" style="margin-left: 10px;"> <tr><td colspan="2" style="text-align: center;">3 min</td></tr> <tr><td>1</td><td> (620)</td></tr> <tr><td>2</td><td> (612)</td></tr> <tr><td>↓</td><td>31.5 mm</td></tr> <tr><td>↔</td><td>119.2 mm</td></tr> </table>	3 min		1	(620)	2	(612)	↓	31.5 mm	↔	119.2 mm
4 min																																											
1	(620)																																										
2	(612)																																										
↓	54.6 mm																																										
↔	80.0 mm																																										
3 min																																											
1	(620)																																										
2	(612)																																										
↓	53.9 mm																																										
↔	75.0 mm																																										
3 min																																											
1	(620)																																										
2	(612)																																										
↓	54.2 mm																																										
↔	73.2 mm																																										
3 min																																											
1	(620)																																										
2	(612)																																										
↓	31.5 mm																																										
↔	119.2 mm																																										
<p>No.5</p>  <table border="1" style="margin-left: 10px;"> <tr><td colspan="2" style="text-align: center;">3 min</td></tr> <tr><td>1</td><td> (620)</td></tr> <tr><td>2</td><td> (612)</td></tr> <tr><td>↓</td><td>55.0 mm</td></tr> <tr><td>↔</td><td>65.3 mm</td></tr> </table>	3 min		1	(620)	2	(612)	↓	55.0 mm	↔	65.3 mm	<p>No.13</p>  <table border="1" style="margin-left: 10px;"> <tr><td colspan="2" style="text-align: center;">4 min</td></tr> <tr><td>1</td><td> (620)</td></tr> <tr><td>2</td><td> (612)</td></tr> <tr><td>↓</td><td>54.1 mm</td></tr> <tr><td>↔</td><td>85.0 mm</td></tr> </table>	4 min		1	(620)	2	(612)	↓	54.1 mm	↔	85.0 mm	<p>No.21</p>  <table border="1" style="margin-left: 10px;"> <tr><td colspan="2" style="text-align: center;">3 min</td></tr> <tr><td>1</td><td> (620)</td></tr> <tr><td>2</td><td> (612)</td></tr> <tr><td>↓</td><td>53.6 mm</td></tr> <tr><td>↔</td><td>78.3 mm</td></tr> </table>	3 min		1	(620)	2	(612)	↓	53.6 mm	↔	78.3 mm	<p>No.29</p>  <table border="1" style="margin-left: 10px;"> <tr><td colspan="2" style="text-align: center;">2 min</td></tr> <tr><td>1</td><td> (620)</td></tr> <tr><td>2</td><td> (612)</td></tr> <tr><td>↓</td><td>13.4 mm</td></tr> <tr><td>↔</td><td>195.4 mm</td></tr> </table>	2 min		1	(620)	2	(612)	↓	13.4 mm	↔	195.4 mm
3 min																																											
1	(620)																																										
2	(612)																																										
↓	55.0 mm																																										
↔	65.3 mm																																										
4 min																																											
1	(620)																																										
2	(612)																																										
↓	54.1 mm																																										
↔	85.0 mm																																										
3 min																																											
1	(620)																																										
2	(612)																																										
↓	53.6 mm																																										
↔	78.3 mm																																										
2 min																																											
1	(620)																																										
2	(612)																																										
↓	13.4 mm																																										
↔	195.4 mm																																										
<p>No.6</p>  <table border="1" style="margin-left: 10px;"> <tr><td colspan="2" style="text-align: center;">3 min</td></tr> <tr><td>1</td><td> (620)</td></tr> <tr><td>2</td><td> (612)</td></tr> <tr><td>↓</td><td>54.0 mm</td></tr> <tr><td>↔</td><td>78.8 mm</td></tr> </table>	3 min		1	(620)	2	(612)	↓	54.0 mm	↔	78.8 mm	<p>No.14</p>  <table border="1" style="margin-left: 10px;"> <tr><td colspan="2" style="text-align: center;">3 min</td></tr> <tr><td>1</td><td> (620)</td></tr> <tr><td>2</td><td> (612)</td></tr> <tr><td>↓</td><td>54.6 mm</td></tr> <tr><td>↔</td><td>84.8 mm</td></tr> </table>	3 min		1	(620)	2	(612)	↓	54.6 mm	↔	84.8 mm	<p>No.22</p>  <table border="1" style="margin-left: 10px;"> <tr><td colspan="2" style="text-align: center;">3 min</td></tr> <tr><td>1</td><td> (620)</td></tr> <tr><td>2</td><td> (612)</td></tr> <tr><td>↓</td><td>53.1 mm</td></tr> <tr><td>↔</td><td>70.9 mm</td></tr> </table>	3 min		1	(620)	2	(612)	↓	53.1 mm	↔	70.9 mm											
3 min																																											
1	(620)																																										
2	(612)																																										
↓	54.0 mm																																										
↔	78.8 mm																																										
3 min																																											
1	(620)																																										
2	(612)																																										
↓	54.6 mm																																										
↔	84.8 mm																																										
3 min																																											
1	(620)																																										
2	(612)																																										
↓	53.1 mm																																										
↔	70.9 mm																																										
<p>No.7</p>  <table border="1" style="margin-left: 10px;"> <tr><td colspan="2" style="text-align: center;">3 min</td></tr> <tr><td>1</td><td> (620)</td></tr> <tr><td>2</td><td> (612)</td></tr> <tr><td>↓</td><td>54.6 mm</td></tr> <tr><td>↔</td><td>70.4 mm</td></tr> </table>	3 min		1	(620)	2	(612)	↓	54.6 mm	↔	70.4 mm	<p>No.15</p>  <table border="1" style="margin-left: 10px;"> <tr><td colspan="2" style="text-align: center;">3 min</td></tr> <tr><td>1</td><td> (620)</td></tr> <tr><td>2</td><td> (612)</td></tr> <tr><td>↓</td><td>53.9 mm</td></tr> <tr><td>↔</td><td>78.7 mm</td></tr> </table>	3 min		1	(620)	2	(612)	↓	53.9 mm	↔	78.7 mm	<p>No.23</p>  <table border="1" style="margin-left: 10px;"> <tr><td colspan="2" style="text-align: center;">4 min</td></tr> <tr><td>1</td><td> (620)</td></tr> <tr><td>2</td><td> (612)</td></tr> <tr><td>↓</td><td>53.4 mm</td></tr> <tr><td>↔</td><td>82.6 mm</td></tr> </table>	4 min		1	(620)	2	(612)	↓	53.4 mm	↔	82.6 mm	<p>No.1</p>  <table border="1" style="margin-left: 10px;"> <tr><td colspan="2" style="text-align: center;">4 min</td></tr> <tr><td>1</td><td> (620)</td></tr> <tr><td>2</td><td> (612)</td></tr> <tr><td>↓</td><td>54.3 mm</td></tr> <tr><td>↔</td><td>82.8 mm</td></tr> </table>	4 min		1	(620)	2	(612)	↓	54.3 mm	↔	82.8 mm
3 min																																											
1	(620)																																										
2	(612)																																										
↓	54.6 mm																																										
↔	70.4 mm																																										
3 min																																											
1	(620)																																										
2	(612)																																										
↓	53.9 mm																																										
↔	78.7 mm																																										
4 min																																											
1	(620)																																										
2	(612)																																										
↓	53.4 mm																																										
↔	82.6 mm																																										
4 min																																											
1	(620)																																										
2	(612)																																										
↓	54.3 mm																																										
↔	82.8 mm																																										
<p>No.8</p>  <table border="1" style="margin-left: 10px;"> <tr><td colspan="2" style="text-align: center;">4 min</td></tr> <tr><td>1</td><td> (620)</td></tr> <tr><td>2</td><td> (612)</td></tr> <tr><td>↓</td><td>54.3 mm</td></tr> <tr><td>↔</td><td>83.3 mm</td></tr> </table>	4 min		1	(620)	2	(612)	↓	54.3 mm	↔	83.3 mm	<p>No.16</p>  <table border="1" style="margin-left: 10px;"> <tr><td colspan="2" style="text-align: center;">3 min</td></tr> <tr><td>1</td><td> (620)</td></tr> <tr><td>2</td><td> (612)</td></tr> <tr><td>↓</td><td>54.7 mm</td></tr> <tr><td>↔</td><td>67.2 mm</td></tr> </table>	3 min		1	(620)	2	(612)	↓	54.7 mm	↔	67.2 mm	<p>No.24</p>  <table border="1" style="margin-left: 10px;"> <tr><td colspan="2" style="text-align: center;">3 min</td></tr> <tr><td>1</td><td> (620)</td></tr> <tr><td>2</td><td> (612)</td></tr> <tr><td>↓</td><td>53.2 mm</td></tr> <tr><td>↔</td><td>83.4 mm</td></tr> </table>	3 min		1	(620)	2	(612)	↓	53.2 mm	↔	83.4 mm											
4 min																																											
1	(620)																																										
2	(612)																																										
↓	54.3 mm																																										
↔	83.3 mm																																										
3 min																																											
1	(620)																																										
2	(612)																																										
↓	54.7 mm																																										
↔	67.2 mm																																										
3 min																																											
1	(620)																																										
2	(612)																																										
↓	53.2 mm																																										
↔	83.4 mm																																										

Embroidery Patterns Color Change Table
Tableau de changement de couleur des motifs de broderie
Tabella dei cambi colore dei ricami
Tabela de alteração de cor do padrão de bordado

Stickdesign-Farbtabelle
Kleurenvolgorde voor de borduurontwerpen
Tabla de cambios de color para diseños de bordado

- Appliqué alphabet
- Applicatie lettertype
- Alfabeto para apliques

- Buchstabenapplikationen
- Alabeto in appliqué

- Alphabet d'appliqués
- Diseños alfabéticos con adornos



* Approximate size/Ungefähre Größe/Taille approximative/Afmeting (ongeveer)/
 Dimensioni approssimative/Tamaño aproximado/Tamanho aproximado

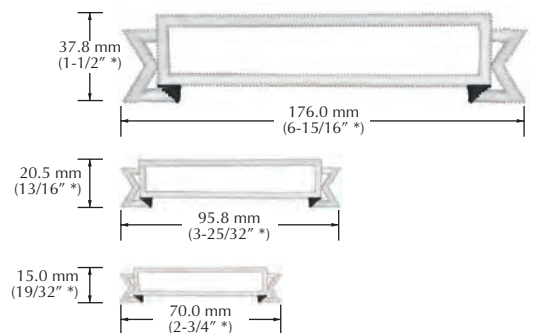
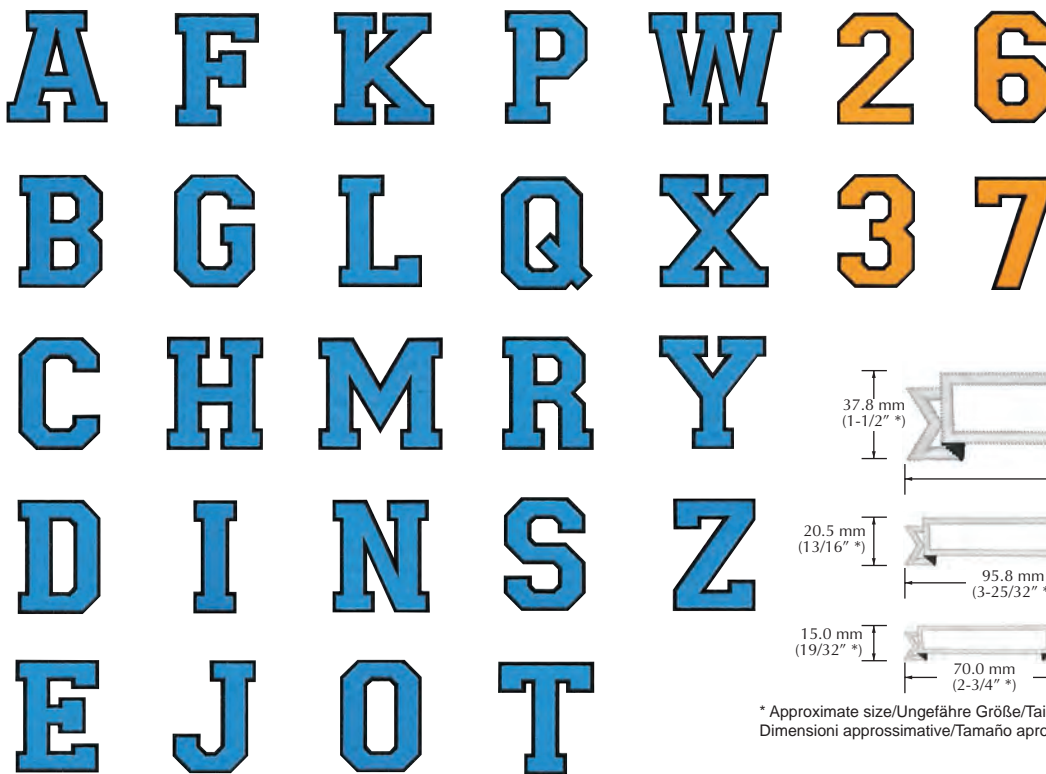

* Approximate size/Ungefähre Größe/Taille approximative/Afmeting (ongeveer)/
 Dimensioni approssimative/Tamaño aproximado/Tamanho aproximado

- ♥ Refer to the operation manual for the embroidery machine for details on how to embroider appliqués.
- ♥ Weitere Hinweise zum Stickten von Applikationen finden Sie in der Bedienungsanleitung der Stickmaschine.
- ♥ Reportez-vous au manuel d'instructions de la machine à broder pour plus d'informations sur la broderie des appliqués.
- ♥ Raadpleeg de bedieningshandleiding bij de borduurmachine voor gedetailleerde uitleg over het borduren van applicaties.
- ♥ Consultare il manuale di istruzioni della macchina per ricamare per i dettagli relativi al ricamo in appliqué.
- ♥ Consulte el manual de instrucciones de la máquina de bordar si desea más información sobre cómo bordar apliques.
- ♥ Consulte o manual de operações da máquina de bordar para obter detalhes sobre como bordar apliques.

- Appliqué Greek alphabet
- Grieks applicatie lettertype
- Alfabeto grego para apliques

- Griechische Buchstaben für Applikationen
- Alfabeto greco in appliqué

- Alphabet grec d'appliqués
- Alfabeto griego con adornos



<p>No.1</p> <p>3 min</p> <p>1 ----× (420) 2 ---- (420) 3 (509) 4 ■■■■ (509)</p> <p>↓ 77.8 mm ↔ 80.4 mm</p>	<p>No.7</p> <p>5 min</p> <p>1 ----× (420) 2 ---- (420) 3 (509) 4 ■■■■ (509)</p> <p>↓ 75.9 mm ↔ 78.5 mm</p>	<p>No.13</p> <p>4 min</p> <p>1 ----× (420) 2 ---- (420) 3 (509) 4 ■■■■ (509)</p> <p>↓ 78.3 mm ↔ 78.4 mm</p>	<p>No.19</p> <p>3 min</p> <p>1 ----× (420) 2 ---- (420) 3 (509) 4 ■■■■ (509)</p> <p>↓ 76.1 mm ↔ 68.0 mm</p>
<p>No.2</p> <p>4 min</p> <p>1 ----× (420) 2 ---- (420) 3 (509) 4 ■■■■ (509)</p> <p>↓ 76.0 mm ↔ 70.7 mm</p>	<p>No.8</p> <p>5 min</p> <p>1 ----× (420) 2 ---- (420) 3 (509) 4 ■■■■ (509)</p> <p>↓ 80.2 mm ↔ 73.9 mm</p>	<p>No.14</p> <p>5 min</p> <p>1 ----× (420) 2 ---- (420) 3 (509) 4 ■■■■ (509)</p> <p>↓ 76.1 mm ↔ 68.5 mm</p>	<p>No.20</p> <p>3 min</p> <p>1 ----× (420) 2 ---- (420) 3 (509) 4 ■■■■ (509)</p> <p>↓ 75.9 mm ↔ 79.1 mm</p>
<p>No.3</p> <p>3 min</p> <p>1 ----× (420) 2 ---- (420) 3 (509) 4 ■■■■ (509)</p> <p>↓ 76.0 mm ↔ 68.2 mm</p>	<p>No.9</p> <p>2 min</p> <p>1 ----× (420) 2 ---- (420) 3 (509) 4 ■■■■ (509)</p> <p>↓ 76.0 mm ↔ 38.1 mm</p>	<p>No.15</p> <p>3 min</p> <p>1 ----× (420) 2 ---- (420) 3 (509) 4 ■■■■ (509)</p> <p>↓ 80.3 mm ↔ 73.9 mm</p>	<p>No.21</p> <p>5 min</p> <p>1 ----× (420) 2 ---- (420) 3 (509) 4 ■■■■ (509)</p> <p>↓ 75.9 mm ↔ 78.0 mm</p>
<p>No.4</p> <p>3 min</p> <p>1 ----× (420) 2 ---- (420) 3 (509) 4 ■■■■ (509)</p> <p>↓ 77.7 mm ↔ 70.0 mm</p>	<p>No.10</p> <p>4 min</p> <p>1 ----× (420) 2 ---- (420) 3 (509) 4 ■■■■ (509)</p> <p>↓ 76.1 mm ↔ 80.5 mm</p>	<p>No.16</p> <p>4 min</p> <p>1 ----× (420) 2 ---- (420) 3 (509) 4 ■■■■ (509)</p> <p>↓ 75.9 mm ↔ 82.6 mm</p>	<p>No.22</p> <p>4 min</p> <p>1 ----× (420) 2 ---- (420) 3 (509) 4 ■■■■ (509)</p> <p>↓ 76.0 mm ↔ 80.8 mm</p>
<p>No.5</p> <p>4 min</p> <p>1 ----× (420) 2 ---- (420) 3 (509) 4 ■■■■ (509)</p> <p>↓ 76.1 mm ↔ 69.8 mm</p>	<p>No.11</p> <p>3 min</p> <p>1 ----× (420) 2 ---- (420) 3 (509) 4 ■■■■ (509)</p> <p>↓ 78.0 mm ↔ 76.0 mm</p>	<p>No.17</p> <p>3 min</p> <p>1 ----× (420) 2 ---- (420) 3 (509) 4 ■■■■ (509)</p> <p>↓ 76.0 mm ↔ 62.0 mm</p>	<p>No.23</p> <p>4 min</p> <p>1 ----× (420) 2 ---- (420) 3 (509) 4 ■■■■ (509)</p> <p>↓ 76.0 mm ↔ 86.7 mm</p>
<p>No.6</p> <p>3 min</p> <p>1 ----× (420) 2 ---- (420) 3 (509) 4 ■■■■ (509)</p> <p>↓ 76.0 mm ↔ 67.4 mm</p>	<p>No.12</p> <p>5 min</p> <p>1 ----× (420) 2 ---- (420) 3 (509) 4 ■■■■ (509)</p> <p>↓ 76.0 mm ↔ 95.3 mm</p>	<p>No.18</p> <p>4 min</p> <p>1 ----× (420) 2 ---- (420) 3 (509) 4 ■■■■ (509)</p> <p>↓ 76.0 mm ↔ 69.0 mm</p>	<p>No.24</p> <p>5 min</p> <p>1 ----× (420) 2 ---- (420) 3 (509) 4 ■■■■ (509)</p> <p>↓ 78.0 mm ↔ 74.1 mm</p>

- Refer to the operation manual for the embroidery machine for details on how to embroider appliqués.
- Weitere Hinweise zum Sticken von Applikationen finden Sie in der Bedienungsanleitung der Stickmaschine.
- Reportez-vous au manuel d'instructions de la machine à broder pour plus d'informations sur la broderie des appliqués.
- Raadpleeg de bedieningshandleiding bij de borduurmachine voor gedetailleerde uitleg over het borduren van applicaties.
- Consultare il manuale di istruzioni della macchina per ricamare per i dettagli relativi al ricamo in appliqué.
- Consulte el manual de instrucciones de la máquina de bordar si desea más información sobre cómo bordar apliques.
- Consulte o manual de operações da máquina de bordar para obter detalhes sobre como bordar apliques.

- ❖ Monograms
- ❖ Monogrammes
- ❖ Monogrammi
- ❖ Monogramas

- ❖ Monogramme
- ❖ Monogrammen
- ❖ Monogramas

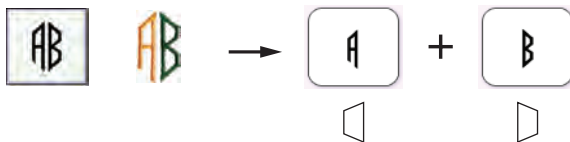
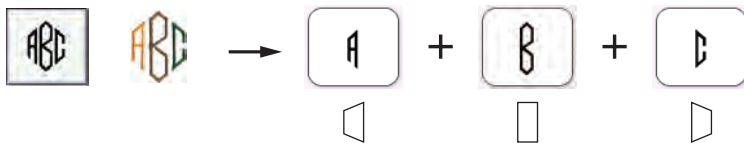
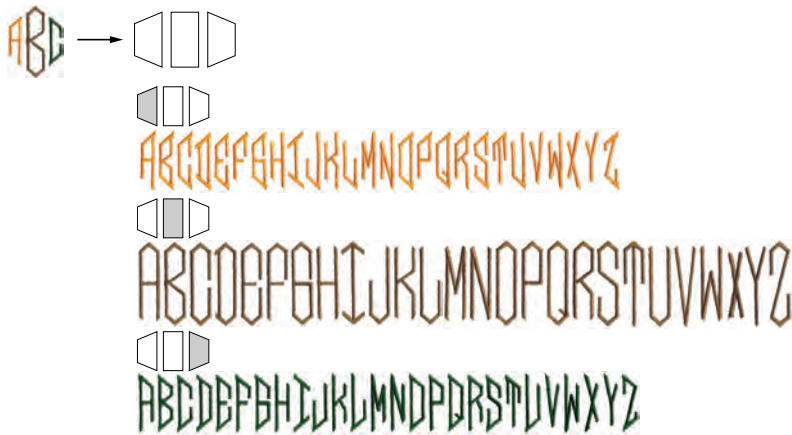

- Monogram Frames
- Monogramkaders en omrandingen
- Molduras de monograma
- Monogrammrahmen
- Cornici per monogramma
- Encadrements pour monogrammes
- Costuras de encuadre con texto de monograma

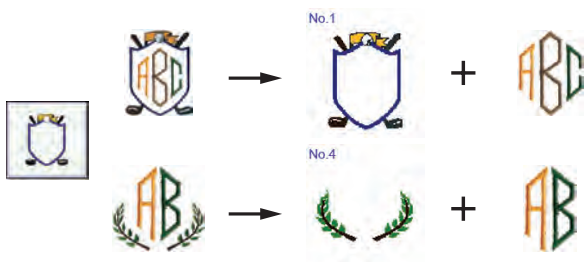

❖ Monogram Frames

❖ Encadrements pour monogrammes

❖ Cornici per monogramma

❖ Molduras de monograma

❖ Monogrammrahmen

❖ Monogramkaders en omrandingen

❖ Costuras de encuadre con texto de monograma



No.1

L: 5 min	
M: 3 min	
S: 2 min	
1	□ (001)
2	■ (058)
3	■ (208)
4	■ (707)
5	■ (007)
↓	94.4 mm
L:	↔ 73.6 mm
↓	64.1 mm
M:	↔ 50.1 mm
↓	40.9 mm
S:	↔ 31.2 mm

No.4

L: 2 min	
M: 1 min	
S: 1 min	
1	■ (515)
2	■ (058)
↓	48.4 mm
L:	↔ 92.5 mm
↓	31.2 mm
M:	↔ 59.5 mm
↓	19.1 mm
S:	↔ 36.4 mm

No.7

L: 2 min	
M: 1 min	
S: 1 min	
1	■ (214)
2	■ (843)
↓	84.8 mm
L:	↔ 84.8 mm
↓	55.0 mm
M:	↔ 54.9 mm
↓	33.9 mm
S:	↔ 33.9 mm

No.2

L: 5 min	
M: 3 min	
S: 2 min	
1	□ (001)
2	■ (513)
3	■ (208)
4	■ (007)
5	■ (900)
↓	90.1 mm
L:	↔ 81.6 mm
↓	60.2 mm
M:	↔ 54.9 mm
↓	38.8 mm
S:	↔ 36.1 mm

No.5

L: 1 min	
M: 1 min	
S: 1 min	
1	■ (205)
2	■ (085)
3	■ (612)
4	■ (800)
↓	92.5 mm
L:	↔ 78.9 mm
↓	59.6 mm
M:	↔ 50.9 mm
↓	34.9 mm
S:	↔ 29.7 mm

No.8

L: 2 min	
M: 1 min	
S: 1 min	
1	■ (507)
2	■ (800)
↓	94.9 mm
L:	↔ 94.4 mm
↓	63.6 mm
M:	↔ 63.9 mm
↓	39.9 mm
S:	↔ 40.2 mm

No.3

L: 3 min	
M: 2 min	
S: 1 min	
1	■ (323)
↓	93.8 mm
L:	↔ 64.5 mm
↓	61.4 mm
M:	↔ 42.6 mm
↓	40.3 mm
S:	↔ 27.5 mm

No.6

L: 3 min	
M: 1 min	
S: 1 min	
1	■ (328)
↓	77.5 mm
L:	↔ 78.2 mm
↓	50.0 mm
M:	↔ 50.4 mm
↓	29.7 mm
S:	↔ 29.9 mm

No.9

L: 3 min	
M: 1 min	
S: 1 min	
1	■ (900)
2	■ (515)
3	■ (214)
↓	94.6 mm
L:	↔ 72.3 mm
↓	59.5 mm
M:	↔ 46.0 mm
↓	37.2 mm
S:	↔ 28.8 mm

Embroidery Patterns Color Change Table
Tableau de changement de couleur des motifs de broderie
Tabella dei cambi colore dei ricami
Tabela de alteração de cor do padrão de bordado

Stickdesign-Farbtabelle
Kleurenvolgorde voor de borduurontwerpen
Tabla de cambios de color para diseños de bordado

No.10



L: 2 min	M: 1 min	S: 1 min
1	■ (534)	
	↓ 83.4 mm	
L:	↔ 98.7 mm	
	↓ 56.1 mm	
M:	↔ 66.8 mm	
	↓ 35.1 mm	
S:	↔ 41.8 mm	

No.12



L: 1 min	M: 1 min	S: 1 min
1	■ (070)	
2	■ (612)	
	↓ 22.7 mm	
L:	↔ 90.0 mm	
	↓ 14.5 mm	
M:	↔ 57.4 mm	
	↓ 8.9 mm	
S:	↔ 34.6 mm	

No.14



L: 1 min	M: 1 min	S: 1 min
1	■ (800)	
	↓ 24.4 mm	
L:	↔ 88.1 mm	
	↓ 15.1 mm	
M:	↔ 56.7 mm	
	↓ 8.4 mm	
S:	↔ 38.9 mm	

No.11



L: 1 min	M: 1 min	S: 1 min
1	■ (620)	
	↓ 25.2 mm	
L:	↔ 89.4 mm	
	↓ 16.8 mm	
M:	↔ 57.4 mm	
	↓ 9.1 mm	
S:	↔ 34.0 mm	

No.13



L: 1 min	M: 1 min	S: 1 min
1	■ (208)	
	↓ 28.3 mm	
L:	↔ 91.4 mm	
	↓ 18.4 mm	
M:	↔ 59.0 mm	
	↓ 11.4 mm	
S:	↔ 36.1 mm	

No.15



L: 2 min	M: 1 min	S: 1 min
1	■ (214)	
2	■ (058)	
	↓ 24.3 mm	
L:	↔ 54.4 mm	
	↓ 15.5 mm	
M:	↔ 34.7 mm	
	↓ 9.3 mm	
S:	↔ 20.8 mm	

Examples of Combinations Exemples de combinaisons Esempi di combinazioni Exemplos de combinações

Kombinationsbeispiele Voorbeelden van combinaties Ejemplos de combinaciones

- Embroidery patterns on these pages are illustration images, which may be different from the patterns in your machine.
- Les motifs de broderie figurant sur ces pages sont des images d'illustration qui peuvent différer des motifs proposés par votre machine.
- I ricami di queste pagine sono immagini a scopo illustrativo, che potrebbero differire dai ricami della macchina.
- Os padrões de bordado nestas páginas são imagens ilustrativas, que podem ser diferentes dos padrões em sua máquina.

- Die auf diesen Seiten abgebildeten Stickmuster dienen nur der Illustration; sie können von den Mustern in Ihrer Maschine abweichen.
- De weergegeven borduurpatronen in deze illustraties dienen als voorbeeld. Het is mogelijk dat ze af wijken van de borduurpatronen in de machine.
- Los diseños de bordado de estas páginas son ilustraciones, que pueden ser diferentes de los diseños de la máquina.



No.3 +



No.4 +



No.5 = (900)



No.3 + No.5 × 2



No.16 × 2 + No.17 × 2



No.8 + No.9 × 2



No.3 × 2

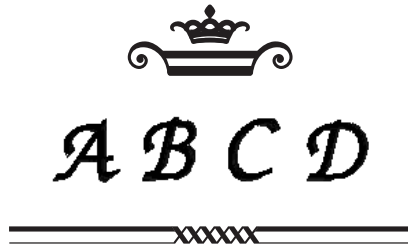
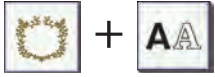

No.14 + No.15



No.12 x 2

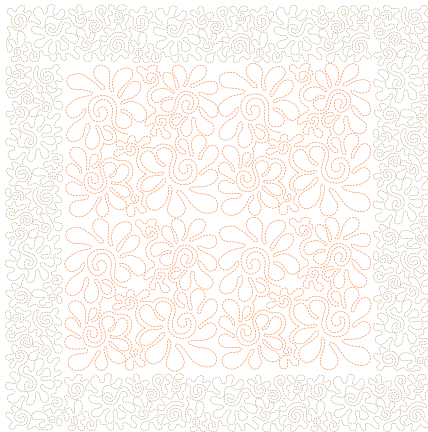

No.2 x 4 + No.14 x 12

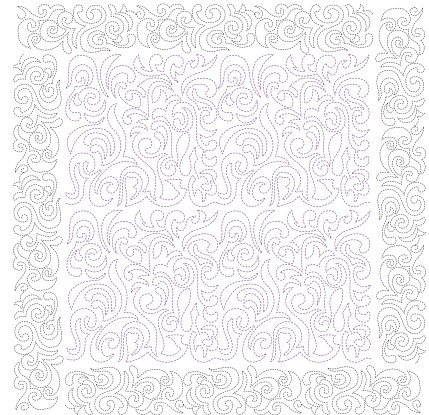

No.8 x 4 + No.16 x 12

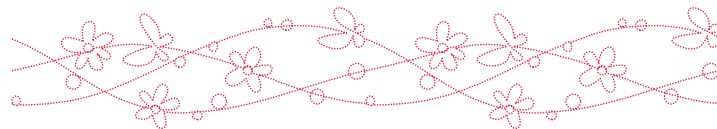

No.17 x 2



No.2 + No.27 x 2



No.6 + No.10 + No.19



No.2 + No.28 x 2

Create 3D embroidery Créer une broderie 3D Creare ricami 3D Criar bordados 3D

Erstellen von 3D-Stickereien Creëer 3D-borduurwerk Crear bordados en 3D

You can make 3D embroidery by using urethane foam for embroidery. Refer to the operation manual for the embroidery machine for details on how to embroider 3D font.

Vous pouvez créer une broderie 3D en utilisant de la mousse puffy pour la broderie. Reportez-vous au manuel d'instructions de la machine à broder pour plus d'informations sur la broderie des polices 3D.

Puoi realizzare ricami in 3D utilizzando la gommina o schiuma di poliuretano per ricamo. Consulta il manuale di istruzioni della macchina per ricamare per sapere come realizzare i caratteri 3D.

Você pode fazer bordados 3D usando espuma de uretano para bordar. Consulte o Manual de Operações da máquina de bordar para saber mais sobre como bordar fontes 3D.

Zum Sticken von 3D-Stickereien können Sie Moosgummi verwenden. Weitere Hinweise zum Sticken von 3D-Schriftarten finden Sie in der Bedienungsanleitung der Stickmaschine.

Creëer 3D-borduurwerk met gebruik van foam-materialen. Raadpleeg de bedieningshandleiding bij de borduurmachine voor gedetailleerde uitleg over het borduren van 3D-lettertypen.

Puede realizar bordados en 3D utilizando espuma de uretano para bordar. Consulte el manual de instrucciones de la máquina de bordar si desea más información sobre cómo bordar el tipo de letra 3D.



Instruction Video
Anleitungsvideo
Vidéo d'instructions
Instructievideo
Video con istruzioni
Vídeo de instrucciones
Vídeo de instruções



<https://s.brother/cvcab/>

* We recommend that flat brim cap frame (sold separately) be used for embroidering caps. Visit our website <https://s.brother/cocab/>.

* Zum Besticken von Kappen empfehlen wir die Verwendung des flachen Kappenrahmens (separat erhältlich). Besuchen Sie unsere Website <https://s.brother/cocab/>.

* Nous recommandons d'utiliser le cadre à broder pour casquette à bord plat (vendu séparément) pour broder des casquettes. Visitez notre site Web <https://s.brother/cocab/>.

* We adviseren om een "Pettenframe voor diverse pet modellen" (afzonderlijk verkrijgbaar) te gebruiken voor het borduren van petten. Ga naar onze website <https://s.brother/cocab/>.

* Si consiglia di utilizzare il telaio per cappelli con visiera piatta (venduto separatamente) per ricamare i cappelli. Visitare il nostro sito Web <https://s.brother/cocab/>.

* Recomendamos utilizar el bastidor para gorras (no incluido) para bordar gorras. Visite nuestro sitio web <https://s.brother/cocab/>.

* Recomendamos que o bastidor para bonés de aba reta (vendido separadamente) seja usado para bordar bonés. Visite nosso site <https://s.brother/cocab/>.

Font Name Chart
 Tableau des noms de polices
 Tabella nomi dei font
 Quadro de nomes de fontes

Tabelle der Schriftarten
 Overzicht lettertypen
 Diagrama de nombre de las fuentes

1		Künstlerschreibschrift
2		Block 01
3		Serif 01
4		Brussels Demi Outline
5		Tennessee ExtraBold
6		Brussels Light
7		Serif 02
8		Calgary MediumItalic
9		Maryland
10		Vermont
11		Dalliance Script
12		Sicilia Light Italic (Sicilia)
13		Luedickital
14		Toms Handwritten
15		Bergen
16		Tirol
17		Istanbul
18		San Diego

19		Los Angeles
20		Saipan
21		Gothic 01
22		Bayern Book
23		Florida Medium
24		Lillehammer
25		Dalliance Roman
26		Helsinki Nallow S*
27		Riesa S*
28		Germany S*
29		Script 01 SR*
30		Block 01*
31		Utah Bold Cyrillic
32		PC Tennessee Bold Cyrillic
33		Letter Gothic Bold

- *Small font
- *Kleine Schriftart
- *Petite police
- *Klein lettertype
- *Font piccolo
- *Tipo de letra pequeña
- *Fonte pequena